

Pro Systems

Operations Manual

This manual is applicable to the following models:

- FIT-C-PRO
- FIT-W-PRO
- IMG-PRO
- MCS-PRO
- MGS-PRO
- MWS-PRO
- SF-FIT-C-PRO
- SF-FIT-G-PRO
- SF-FIT-W-PRO



Rev. December 2018



Magnum Industries Europe Ltd. t/a Magnum Venus Products

Official Distributor of MVP Range in the United Kingdom and Ireland

Unit 22a, Navigation Drive, Hurst Business Park,
Brierley Hill, West Midlands, DY5 1UT, UK.

phone: +44 (0)1384 486222
email: info@mvpeurope.co.uk
website: www.mvpeurope.co.uk



Table of Contents

Section	Page
• Table of Contents	3
• Safety & Warning Information	4
• Introduction	15
• Getting Started	18
• Priming the Unit	19
• Establishing a Spray Fan	21
• Spray Mix Testing	25
• Performing Daily Tasks	29
• Troubleshooting	42

Safety & Warning Information

Warnings

Due to the vast number of chemicals that could be used and their varying chemical reactions, the buyer and user of this equipment should determine all factors relating to the fluids used, including any of the potential hazards involved. Particular inquiry and investigation should be made into potential dangers relating to toxic fumes, fires, explosions, reaction times, and exposure of human beings to the individual components or their resultant mixtures. MVP assumes no responsibility for loss, damage, expense or claims for bodily injury or property damage, direct or consequential, arising from the use of such chemical components.

The end user is responsible for ensuring that the end product or system complies with all the relevant laws in the country where it is to be used and that all documentation is adhered to.

Recommended Occupational Safety & Health Act (OSHA) Documentation:

- 1910.94 Pertaining to ventilation
- 1910.106 Pertaining to flammable liquids
- 1910.107 Pertaining to spray finishing operations, particularly paragraph (m), Organic Peroxides and Dual Component Coatings

For Additional information, contact the Occupational Safety and Health Administration (OSHA) at <https://www.osha.gov/about.html>.

Recommended National Fire Protection Association (NFPA) Documentation:

- NFPA No.33 Chapter 14 Organic Peroxides and Dual Component Materials
- NFPA No. 63 Dust Explosion Prevention
- NFPA No. 70 National Electrical Code
- NFPA No. 77 Static Electricity
- NFPA No. 91 Blower and Exhaust System
- NFPA No. 654 Plastics Industry Dust Hazards

Fire Extinguisher – code ABC, rating number 4a60bc using Extinguishing Media –Foam, Carbon Dioxide, Dry Chemical, Water Fog, is recommended for this product and applications.

The following general warnings and guidelines are for the setup, use, grounding, maintenance, and repair of equipment. Additional product-specific warnings may be found throughout this manual as applicable. Please contact your nearest MVP Technical Service Representative if additional information is needed.

Safety Precautions

- Avoid skin contact and inhalation of all chemicals.
- Review Material Safety Data Sheet (MSDS) to promote the safe handling of chemicals in use.
- Restrict the use of all chemicals to designated areas with good ventilation.
- Chemicals are flammable and reactive.
- Noxious fumes released when combusted.
- Operate equipment in a ventilated environment only.
- Uncured liquid resins are highly flammable unless specifically labeled otherwise.
- Cured laminate, accumulations of overspray, and laminate sandings are highly combustible.
- Do not operate or move electrical equipment when flammable fumes are present.
- Ground all equipment.
- If a spark is seen or felt, immediately halt operation. Do not operate the equipment until the issue has been identified and repaired.
- Contaminated catalyst may cause fire or explosion.
- Containers may explode if exposed to fire / heat.
- Use and store chemicals away from heat, flames, and sparks.
- Do not smoke in work areas or near stored chemicals.
- Do not mix Methyl Ethyl Ketone Peroxide (MEKP) with materials other than polyethylene.
- Do not dilute MEKP.
- Keep food and drink away from work area.



Physical Hazards

- Never look directly into the spray gun fluid tip. Serious injury or death can result.
- Never aim the spray gun at or near another person. Serious injury or death can result.
- Chemical compounds can be severely irritating to the eyes and skin.
- Inhalation, ingestion, or injection may damage internal organs and lead to pulmonary disorders, cancers, lymphomas, and other diseases or health conditions.
- Other potential health effects include: irritation of the eyes and upper respiratory tract, headache, light-headedness, dizziness, confusion, drowsiness, nausea, vomiting, and occasionally abdominal pain.
- Eye contact: Immediately flush with water for at least 15 minutes and seek immediate medical attention.
- Skin Contact: Immediately wash with soap and water and seek immediate medical attention.
- Inhalation: Move the person to fresh air and seek immediate medical attention.
- Do not remove shields, covers, or safety features on equipment that is in use.
- Never place fingers, hands, or any body part near or directly in front of the spray gun fluid tip. The force of the liquid as it exits the spray tip can shoot liquid through the skin.
- Keep hands and body parts away from any moving equipment or components.
- Do not stand under plunger
- An improperly loaded drum may lead to an imbalance, causing a unit to tip over

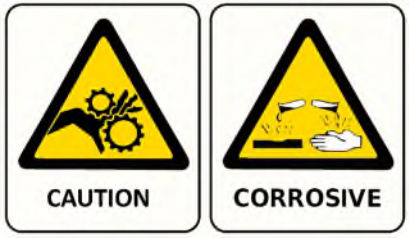

Personal Protective Equipment (PPE)

- MVP recommends the use of personal safety equipment with all products in our catalog.
- Wear safety goggles, hearing protection, a respirator, and chemical resistant gloves.
- Wear long sleeve shirts or jackets and pants to minimize skin exposure.
- PPE should be worn by operators and service technicians to reduce the risk of injury.



For Additional information, contact the Occupational Safety and Health Administration (OSHA). <https://www.osha.gov/about.html>

Symbol Definitions



Indicates the risk of contact with chemicals that are hazardous, which may lead to injury or death.



Indicates the risk of contact with voltage / amperage that may lead to serious injury or death.



Indicates that the materials being used are susceptible to combustion.



Indicates the risk of contact with moving components that may lead to serious injury or death.



Indicates that the system or component should be grounded before proceeding with use or repair.



Indicates the use of lit cigarettes or cigars is prohibited, because the materials being used are susceptible to combustion.



Indicates that the materials and/or the process being performed can lead to ignition and explosion.



A recommendation for the use of Personal Protective Equipment (PPE) before using or repairing the product.

Polymer Matrix Materials: Advanced Composites

Potential health hazards associated with the use of advanced composites can be controlled through the implementation of an effective industrial hygiene and safety program.

https://www.osha.gov/dts/osta/otm/otm_iii/otm_iii_1.html#t_iii:1_1

Resins		
Composite Component	Organ System Target (Possible Target)	Known (Possible) Health Effect
Epoxy resins	Skin, lungs, eyes	Contact and allergic dermatitis, conjunctivitis
Polyurethane resins	Lungs, skin, eyes	Respiratory sensitization, contact dermatitis, conjunctivitis
Phenol formaldehyde	Skin, lungs, eyes	As above (potential carcinogen)
Bismaleimides (BMI)	Skin, lungs, eyes	As above (potential carcinogen)
Polyamides	Skin, lungs, eyes	As above (potential carcinogen)
Reinforcing materials		
Composite Component	Organ System Target (Possible Target)	Known (Possible) Health Effect
Aramid fibers	Skin (lungs)	Skin and respiratory irritation, contact dermatitis (chronic interstitial lung disease)
Carbon/graphite fibers	Skin (lungs)	As noted for aramid fibers
Glass fibers (continuous filament)	Skin (lungs)	As noted for aramid fibers
Hardeners and curing agents		
Composite Component	Organ System Target (Possible Target)	Known (Possible) Health Effect
Diaminodiphenylsulfone	N/A	No known effects with workplace exposure
Methylenedianiline	Liver, skin	Hepatotoxicity, suspect human carcinogen
Other aromatic amines		
Composite Component	Organ System Target (Possible Target)	Known (Possible) Health Effect
Meta-phenylenediamine (MPDA)	Liver, skin (kidney, bladder)	Hepatitis, contact dermatitis (kidney and bladder cancer)
Aliphatic and cyclo-aliphatic amines	Eyes, skin	Severe irritation, contact dermatitis
Polyaminoamide	Eyes, skin	Irritation (sensitization)
Anhydride	Eyes, lungs, skin	Severe eye and skin irritation, respiratory sensitization, contact dermatitis

Catalyst - Methyl Ethyl Ketone Peroxide (MEKP)

MEKP is among the more hazardous materials found in commercial channels. The safe handling of the “unstable (reactive)” chemicals presents a definite challenge to the plastics industry. The highly reactive property which makes MEKP valuable to the plastics industry in producing the curing reaction of polyester resins also produces the hazards which require great care and caution in its storage, transportation, handling, processing and disposal. MEKP is a single chemical. Various polymeric forms may exist which are more or less hazardous with respect to each other. These differences may arise not only from different molecular structures (all are, nevertheless, called “MEKP”) and from possible trace impurities left from the manufacture of the chemicals, but may also arise by contamination of MEKP with other materials in its storage or use. Even a small amount of contamination with acetone, for instance, may produce an extremely shock-sensitive and explosive compound.



WARNING

Contamination with promoters, materials containing promoters (such as laminate sandings), or with any readily oxidizing material (such as brass or iron) will cause exothermic redox reactions which can be explosive in nature. Heat applied to MEKP or heat buildup from contamination reactions can cause the material to reach its Self-Accelerating Decomposition Temperature (SADT).

Researchers have reported measuring pressure rates-of-rise well over 100,000 psi per second when certain MEKP's reach their SADT. For comparison, the highest-pressure rate-of-rise listed in NFPA Bulletin NO.68, “Explosion Venting”, is 12,000 psi per second for an explosion of 12% acetylene and air. The maximum value listed for a hydrogen explosion is 10,000 psi per second. Some forms of MEKP, if allowed to reach their SADT, will burst even an open topped container. This suggests that it is not possible to design a relief valve to vent this order of magnitude of pressure rate-of-rise. The user should be aware that any closed container, be it a pressure vessel, surge chamber, or pressure accumulator, could explode under certain conditions. There is no engineering substitute for care by the user in handling organic peroxide catalysts. If, at any time, the pressure relieve valve on top of the catalyst tank should vent, the area should be evacuated at once and the fire department called. The venting could be the first indication of a heat, and therefore, pressure build-up that could eventually lead to an explosion. Moreover, if a catalyst tank is sufficiently full when the pressure relief valve vents, some catalyst may spray out, which could cause eye injury. For this reason, and many others, anyone whose job puts them in an area where this vented spray might go, should always wear full eye protection even when laminating operations are not taking place.

Safety in handling MEKP depends to a great extent on employee education, proper safety instructions, and safe use of the chemicals and equipment. Workers should be thoroughly informed of the hazards that may result from improper handling of MEKP, especially regarding contamination, heat, friction and impact. They should be thoroughly instructed regarding the proper action to be taken in the storage, use, and disposal of MEKP and other hazardous materials used in the laminating operation. In addition, users should make every effort to:

- Store MEKP in a cool, dry place in original containers away from direct sunlight and away from other chemicals.
- Keep MEKP away from heat, sparks, and open flames.
- Prevent contamination or MEKP with other materials, including polyester over spray and sandings, polymerization accelerators and promoters, brass, aluminum, and non-stainless steels.

- Never add MEKP to anything that is hot, since explosive decomposition may result.
- Avoid contact with skin, eyes, and clothing. Protective equipment should be worn at all times. During clean-up of spilled MEKP, personal safety equipment, gloves, and eye protection must be worn. Firefighting equipment should be at hand and ready.
- Avoid spillage, which can heat up to the point of self-ignition.
- Repair any leaks discovered in the catalyst system immediately, and clean-up the leaked catalyst at once in accordance with the catalyst manufacturer's instructions.
- Use only original equipment or equivalent parts from Magnum Venus Products in the catalyst system (i.e.: hoses, fitting, etc.) because a dangerous chemical reaction may result between substituted parts and MEKP.
- Catalyst accumulated from the purging of hoses or the measurement of fluid output deliveries should never be returned to the supply tank, such catalyst should be diluted with copious quantities of clean water and disposed of in accordance with the catalyst manufacturer's instructions.

The extent to which the user is successful in accomplishing these ends and any additional recommendations by the catalyst manufacturer determines largely the safety that will be present in his operation.

Clean-Up Solvents and Resin Diluents



WARNING

A hazardous situation may be present in your pressurized fluid system! Hydro carbon solvents can cause an explosion when used with aluminum or galvanized components in a closed (pressurized) fluid system (pump, heaters, filters, valves, spray guns, tanks, etc.). An explosion could cause serious injury, death, and/or substantial property damage. Cleaning agents, coatings, paints, etc. may contain Halogenated Hydrocarbon solvents. Some Magnum Venus Products spray equipment includes aluminum or galvanized components and will be affected by Halogenated Hydrocarbon solvents.

There are three key elements to the Halogenated Hydrocarbon (HHC) solvent hazard.

- | | | |
|----|---|--|
| 1. | The presence of HHC solvents. | 1,1,1 – Trichloroethane and Methylene Chloride are the most common of these solvents. However, other HHC solvents are suspect if used; either as part of paint or adhesives formulation, or for clean-up flushing. |
| 2. | Aluminum or Galvanized Parts. | Most handling equipment contains these elements. In contact with these metals, HHC solvents could generate a corrosive reaction of a catalytic nature. |
| 3. | Equipment capable of withstanding pressure. | When HHC solvent contact aluminum or galvanized parts inside a closed container such as a pump, spray gun, or fluid handling system, the chemical reaction can, over time, result in a build-up of heat and pressure, which can reach explosive proportions. When all three elements are present, the result can be an extremely violent explosion. The reaction can be sustained with very little aluminum or galvanized metal; any amount of aluminum is too much. |

- The reaction is unpredictable. Prior use of an HHC solvent without incident (corrosion or explosion) does NOT mean that such use is safe. These solvents can be dangerous alone (as a clean-up or flushing agent) or when used as a component or a coating material. There is no known inhibitor that is effective under all circumstances. Mixing HHC solvents with other materials or solvents such as MEKP, alcohol, or toluene may render the inhibitors ineffective.
- The use of reclaimed solvents is particularly hazardous. Reclaimers may not add any inhibitors. The possible presence of water in reclaimed solvents could also feed the reaction.
- Anodized or other oxide coatings cannot be relied upon to prevent the explosive reaction. Such coatings can be worn, cracked, scratched, or too thin to prevent contact. There is no known way to make oxide coatings or to employ aluminum alloys to safely prevent the chemical reaction under all circumstances.
- Several solvent suppliers have recently begun promoting HHC solvents for use in coating systems. The increasing use of HHC solvents is increasing the risk. Because of their exemption from many state implementation plans as Volatile Organic Compounds (VOCs), their low flammability hazard, and their not being classified as toxic or carcinogenic substances, HHC solvents are very desirable in many respects.



WARNING

Do not use Halogenated Hydrocarbon (HHC) solvents in pressurized fluid systems having aluminum or galvanized wetted parts.

Magnum Venus Products is aware of NO stabilizers available to prevent HHC solvents from reaction under all conditions with aluminum components in closed fluid systems. HHC solvents are dangerous when used with aluminum components in a closed fluid system.

- Consult your material supplier to determine whether your solvent or coating contains Halogenated Hydrocarbon solvents.
- Magnum Venus Products recommends that you contact your solvent supplier regarding the best non-flammable clean-up solvent with the heat toxicity for your application.
- If, however, you find it necessary to use flammable solvents, they must be kept in approved, electrically grounded containers.
- Bulk solvent should be stored in a well-ventilated, separate building, 50 feet away from your main plant.
- You should only allow enough solvent for one day's use in your laminating area.
- NO SMOKING signs must be posted and observed in all areas of storage or where solvents and other flammable materials are used.
- Adequate ventilation (as covered in OSHA Section 1910.94 and NFPA No.91) is important wherever solvents are stored or used, to minimize, confine and exhaust the solvent vapors.
- Solvents should be handled in accordance with OSHA Section 1910.106 and 1910.107.

Catalyst Diluents

Magnum Venus Products spray-up and gel-coat systems currently produced are designed so that catalyst diluents are not required. Magnum Venus Products therefore recommends that diluents not be used to avoid possible contamination which could lead to an explosion due to the handling and mixing of MEKP and diluents. In addition, it eliminates any problems from the diluent being contaminated through rust particles in drums, poor quality control on the part of the diluents suppliers, or any other reason. If diluents are absolutely required, contact your catalyst supplier and follow his instructions explicitly. Preferably the supplier should premix the catalyst to prevent possible “on the job” contamination while mixing.



WARNING

If diluents are not used, remember that catalyst spillage and gun, hose, and packing leaks are potentially more hazardous since each drop contains a higher concentration of catalyst and will therefore react more quickly with overspray and the leak.

Cured Laminate, Overspray and Laminate Sandings Accumulation

- Remove all accumulations of overspray, Fiberglass Reinforced Plastic (FRP) sandings, etc. from the building as they occur. If this waste is allowed to build up, spillage of catalyst is more likely to start a fire; in addition, the fire would burn hotter and longer.
- Floor coverings, if used, should be non-combustible.
- Spilled or leaked catalyst may cause a fire if it comes in contact with an FRP product, oversprayed chop or resin, FRP sandings or any other material with MEKP.

To prevent spillage and leakage, you should:

- | | |
|--|---|
| 1. Maintain your Magnum Venus Products System. | Check the gun several times daily for catalyst and resin packing or valve leaks. REPAIR ALL LEAKS IMMEDIATELY. |
| 2. Never leave the gun hanging over or lying inside the mold. | A catalyst leak in this situation would certainly damage the part, possibly the mold, and may cause a fire. |
| 3. Inspect resin and catalyst hoses daily for wear or stress at the entry and exits of the boom sections and at the hose and fittings. | Replace if wear or weakness is evident or suspected. |
| 4. Arrange the hoses and fiberglass roving guides so that the fiberglass strands DO NOT rub against any of the hoses at any point. | If allowed to rub, the hose will be cut through, causing a hazardous leakage of material which could increase the danger of fire. Also, the material may spew onto personnel in the area. |

Toxicity of Chemicals

- Magnum Venus Products recommends that you consult OSHA Sections 1910.94, 1910.106, 1910.107 and NFPA No.33, Chapter 14, and NFPA No.91.
- Contact your chemical supplier(s) and determine the toxicity of the various chemicals used as well as the best methods to prevent injury, irritation and danger to personnel.
- Also determine the best methods of first aid treatment for each chemical used in your plant.

Equipment Safety

Magnum Venus Products suggest that personal safety equipment such as EYE GOGGLES, GLOVES, EAR PROTECTION, and RESPIRATORS be worn when servicing or operating this equipment. Ear protection should be worn when operating a fiberglass chopper to protect against hearing loss since noise levels can be as high as 116 dB (decibels). This equipment should only be operated or serviced by technically trained personnel!



CAUTION

Never place fingers, hands, or any body part near or directly in front of the spray gun fluid tip. The force of the liquid as it exits the spray tip can cause serious injury by shooting liquid through the skin. NEVER LOOK DIRECTLY INTO THE GUN SPRAY TIP OR POINT THE GUN AT OR NEAR ANOTHER PERSON.



DANGER

Contaminated catalyst may cause fire or explosion. Before working on the catalyst pump or catalyst accumulator, wash hands and tools thoroughly. Be sure work area is free from dirt, grease, or resin. Clean catalyst system components with clean water daily.



DANGER

Eye, skin, and respiration hazard. The catalyst MEKP may cause blindness, skin irritation, or breathing difficulty. Keep hands away from face. Keep food and drink away from work area.

Treatment of Chemical Injuries



CAUTION

Refer to your catalyst manufacturer's safety information regarding the safe handling and storage of catalyst. Wear appropriate safety equipment as recommended.

Great care should be used in handling the chemicals (resins, catalyst and solvents) used in polyester systems. Such chemicals should be treated as if they hurt your skin and eyes and as if they are poison to your body. For this reason, Magnum Venus Products recommends the use of protective clothing and eye wear in using polyester systems. However, users should be prepared in the event of such an injury.

Precautions include:

1. Know precisely what chemicals you are using and obtain information from your chemical supplier on what to do in the event the chemical gets onto your skin or into the eyes, or if swallowed.
2. Keep this information together and easily available so that it may be used by those administering first aid or treating the injured person.
3. Be sure the information from your chemical supplier includes instructions on how to treat any toxic effects the chemicals have.

**WARNING**

Contact your doctor immediately in the event of an injury. If the product's MSDS includes first aid instructions, administer first aid immediately after contacting a doctor.

Fast treatment of the outer skin and eyes that contact chemicals generally includes immediate and thorough washing of the exposed skin and immediate and continuous flushing of the eyes with lots of clean water for at least 15 minutes or more. These general instructions of first aid treatment may be incorrect for some chemicals; you must know the chemicals and treatment before an accident occurs. Treatment for swallowing a chemical frequently depends upon the nature of the chemical.

Emergency Stop Procedure

In an emergency, follow these steps to stop a UPS System:

1. The ball valve located where the air enters the power head of the resin pump, should be moved to the "OFF" or closed position.

Note **The "open" or "on" position is when the ball valve handle is parallel (in line) with the ball valve body. The "closed" or "off" position is when the ball valve handle is perpendicular (across) the ball valve body.**

2. Turn all system regulators to the "OFF" position (counter-clockwise) position.
3. Verify / secure the catalyst relief line, located on the catalyst relief valve.
4. Verify / secure the resin return line, located on the resin filter.
5. Place a container under the resin pump ball valve to catch ejected resin.
6. Locate the ball valve on the resin pump.
7. Rotate the ball valve 90 degrees to the "On" or open position.

Grounding

Grounding an object means providing an adequate path for the flow of the electrical charge from the object to the ground. An adequate path is one that permits charge to flow from the object fast enough that it will not accumulate to the extent that a spark can be formed. It is not possible to define exactly what will be an adequate path under all conditions since it depends on many variables. In any event, the grounding means should have the lowest possible electrical resistance.

Grounding straps should be installed on all loose conductive objects in the spraying area. This includes material containers and equipment. Magnum Venus Products recommends grounding straps be made of AWG No.18 stranded wire as a minimum and the larger wire be used where possible. NFPA Bulletin No77 states that the electrical resistance of such a leakage path may be as low as 1 meg ohm (10 ohms) but that resistance as high as 10,000 meg ohms will produce an adequate leakage path in some cases.



CAUTION

Whenever flammable or combustible liquids are transferred from one container to another, or from one container to the equipment, both containers or container and equipment shall be effectively bonded and grounded to dissipate static electricity. For further information, see National Fire Protection Association (NFPA) 77, titled “Recommended Practice on Static Electrical”. Refer especially to section 7-7 titled “Spray Application of Flammable and Combustible Materials”.

Introduction

This manual provides information for the operation, maintenance, and simple repair of the MVP Pro Systems. The following procedures are included:

- Installation, start-up, and shut-down instructions
- Step-by-step operation instructions



Please read this manual carefully and retain for future reference. Follow the steps in the order given, otherwise you may damage the equipment or injure yourself.

Component Assemblies

MVP's Pro Systems consists of multiple components. Each component has its own detailed manual and drawings. For complete repair and maintenance instructions, refer to the appropriate manuals.

- FLUID SECTION
- AIR MOTOR
- CATALYST PUMP
- GUN ASSEMBLY

Air Requirements

1. The system requires a supply of air (30 cfm) and at least 100 psi (7 bar).
2. The unit requires a ½ inch (12 - 13 mm) inside diameter air hose minimum (use caution when using quick disconnects; they may restrict air flow).
3. Preferably the air will be clean, dry, and oil free.

Overview of Controls

Following is a brief description of the main controls and their function. There are slight variations from system to system and some controls may not be part of your manifold.

Core System Parts	
Description	Function
Pump Pressure Gauge & Regulator	Controls the main air pressure to the air motor
Atomizing Air Gauge & Regulator	Controls the air pressure to the catalyst nozzle on the gun. This is normally set to 18 – 25 psi (1 – 1.5 bar)
Priming Button	Allows priming of the pump without triggering the gun
Dump Valve	Located on the bottom of the filter body and used to relieve material pressure
Main Air Ball Valve	Turns on or off the main air supply to the system

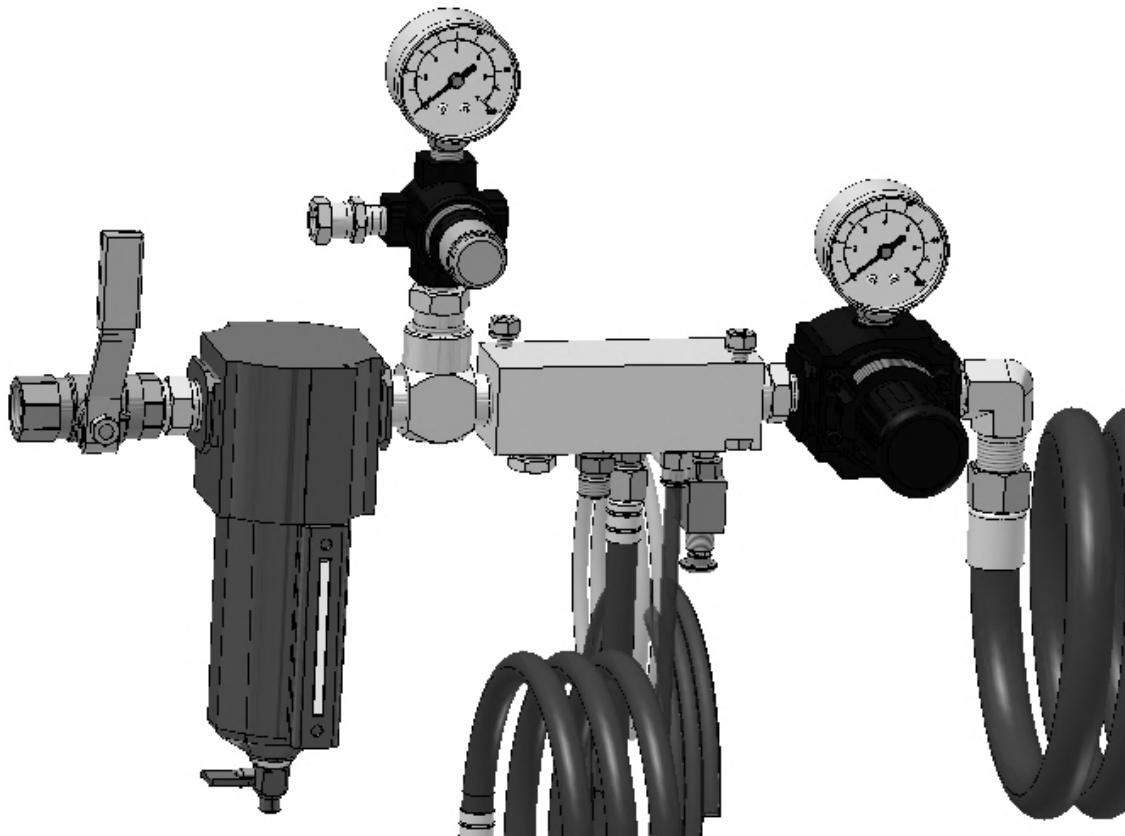

Pump Overview

MVP has a variety of pumps in a wide range of configurations. Most of the pumping systems are based on a double-acting piston pump design. Double-acting piston pumps are a two-ball style pump which delivers material on both the up and down strokes. They are driven by an air motor (available in a variety of sizes).

There are three basic pump sizes:

- Material – lower output systems and material applications
- Chopper/Standard – mid-range output most commonly used for chopper and wetout systems
- High Volume – high volume systems and special or automatic equipment

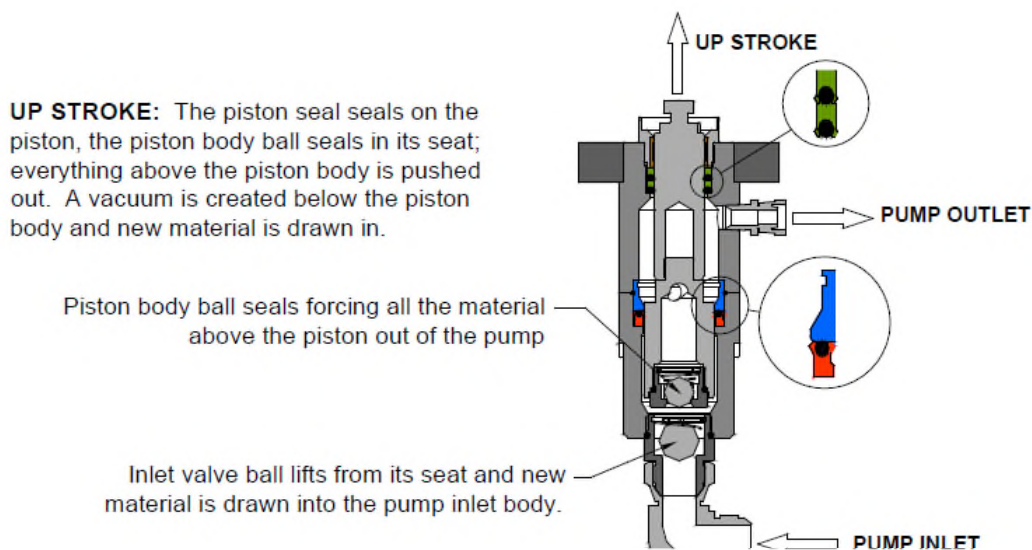

Figure 2. Pump Up Stroke Diagram

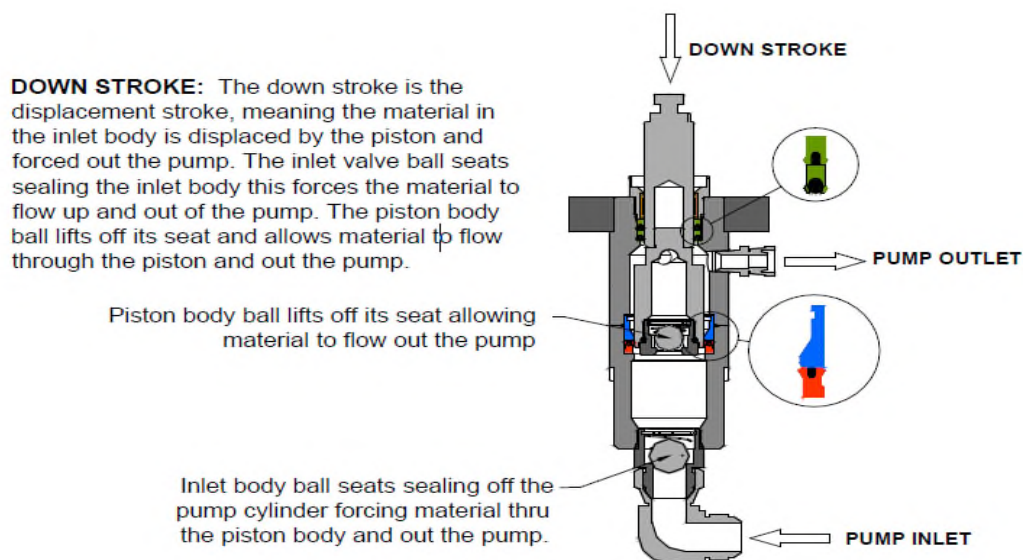

Figure 2. Pump Down Stroke Diagram

Getting Started

Supplies Needed

Lubrication

Throughout this manual, directions are given for lubricating various parts. There are 3 types of lubricant used:

- If the part contacts resin, use MVP Red Grease (6706-2-1).
- If the part is located where it will contact air, use Lubriplate®.
- In the oil reservoir of the pump, use throat seal oil (PAT-LS-OIL).

Other Supplies

- Solvent for cleaning
- A small chip/paint brush for cleaning
- Waste cup or container for solvent
- Wet Gel Gauge to determine material thickness

Setup the Unit

1. Unpack the unit and all components; report any missing or damaged items.
2. Mount the pump to the cart and install the catalyst pump onto the slave arms.

Note ***The catalyst pump must be installed vertically, with the top and bottom pinned to the same percentage on the respective slave arms.***

3. Insert the catalyst jug into the catalyst jug bracket.
4. Connect the relief valve tube to the top port on the catalyst jug.
5. Connect the feed tube from the catalyst jug outlet to the catalyst pump inlet.
6. Connect the catalyst hose to the catalyst pump outlet.
7. Install the material filter and surge chamber assembly.
8. Attach the material hose to the outlet of the filter assembly.
9. Install the air manifold and connect the air hose to the powerhead and air supply to the shift block.
10. Attach hose fittings, catalyst atomizing hose, and gun air supply.
11. Attach pickup hoses to the inlet of the pump.
12. Double check all hose fittings and connections are tight.

Note ***It is important to ensure all fittings and connections are tight to prevent catalyst or material from leaking.***

Priming the Unit



CAUTION

Always wear proper safety equipment (glasses, gloves, respirator, etc.) when working with dispensing equipment and before startup of the unit. Refer to and follow the requirements of the Material Safety Data Sheets (MSDS) supplied by your material manufacturer(s).

The priming procedure will vary depending on if your unit uses an internal or external mix gun. If you are using an internal mix system, skip to Prime Air & Solvent to Internal Mix System. If you are using an external mix system, follow these steps:

Prime Material to External Mix Gun

1. Fill the reservoir cup on the pump $\frac{1}{2}$ full of TSL oil.
2. Insert the material suction wand into a container of material.
3. Clamp or tape the return hose coming from the bottom of the inline filter to the pickup wand into the container.
4. Remove the catalyst tip and spray tip from the front of the material gun.
5. Position the gun over an appropriate container and lock the gun trigger in the open position.
6. Slowly increase the pump regulator pressure until the pump is running at a slow but steady rate.
7. Allow the pump to run until a steady stream of material is being dispensed, then close the gun and brush the front of the gun head clean with solvent.
8. Slowly increase material pump pressure to 100 psi (7 bar) and allow the unit to set under static load for 15 to 30 minutes to seat the resin packing set.
9. Turn the pump regulator to zero.
10. Slowly open the ball valve at the bottom of the resin filter to drain the fluid pressure.

Prime Catalyst to External Mix Gun

11. Remove the catalyst tip and spray tip from the front of the gun.
12. Tighten the catalyst packing nut $\frac{1}{8}$ to $\frac{1}{4}$ turn to snug the packing.
13. Fill the catalyst jug $\frac{3}{4}$ full, then purge the air out of the catalyst feed line by slightly tilting the catalyst jug toward the outlet fitting.
14. Lock or hold the gun trigger in the open position over an appropriate container.
15. Remove the pin from the slave arm and catalyst pump bearing block.
16. Use the priming knob to hand prime catalyst out to the gun until a steady stream is achieved.
17. Release the trigger to close the gun.

18. Replace the pin into the slave arm and catalyst pump bearing block, making sure that the catalyst pump is positioned at the correct percentage.

Note ***The top and bottom of the catalyst pump must be set to the same percentage on their respective slave arms to prevent damage to the catalyst pump.***

19. Skip to Establishing a Spray Fan.

Prime Air & Solvent to Internal Mix System

20. Close the main air inlet valves on the main air manifold.
21. Connect ½ inch main air supply to the air manifold.
22. Turn all regulators counterclockwise to full off and close all ball valves on the unit.
23. Open the recirculation valve on the catalyst manifold.
24. Open the main air feed ball valve and listen for air leaks.

Note ***The ball valve has a safety relief port that will leak air unless the valve is fully open or closed.***

25. Secure all fittings and correct leaks, if found.
26. Fill the flush tank with appropriate cleaning agent at least ¾ full.
27. Close the relief valve on the top of the flush tank.
28. Slowly turn up regulator pressure to the flush tank to between 50 and 60 psi (3.5 – 4 bar).
29. Secure solvent leaks, if any.
30. Test the flush system by pressing the flush button on the gun block.

Prime Material to Internal Mix System

31. Fill the solvent cup on the resin pump with TSL oil.

Note ***Do not install the static mixer on the gun yet. If you have already installed, remove nozzle and mixers from the mix chamber.***

32. Position the gun over an appropriate waste container to allow priming of lines.
33. Pull and lock the gun trigger into the **On** position.
34. Slowly turn up the pump pressure.
35. Slowly turn up the main pump pressure until the pump begins to slowly stroke.
36. Secure leaks, if any.
37. Allow the pump to continue stroking until there is a steady, air-free flow of material from the gun, then close the gun trigger.
38. Position the outlet of the gun over a flush container.
39. Press the flush button to flush the mix chamber.

Prime the Catalyst Pump

40. Fill the catalyst jug at least $\frac{3}{4}$ full.
41. Check for leaks and make sure all fittings are tight.
42. Turn the catalyst recirculation valve to the **On** position.
43. Remove the quick pin from the top slave arm to allow hand priming of catalyst.
44. Hand prime the catalyst until a steady, air-free flow of catalyst is going back to the jug.
45. Position the gun over an appropriate waste container and lock into the **On** position.
46. Close the catalyst recirculation valve on the catalyst manifold.
47. Hand pump the catalyst again through the catalyst hose until there is a steady, air-free flow of catalyst coming from the gun.
48. Release the gun trigger and properly flush and clean the gun.
49. Place the catalyst recirculation valve in the **On** position while the resin pressure is primed.

Establishing a Spray Fan

Set Up the Gun

1. Use a little red grease on the O-rings and threads of the spray tip, catalyst tip, and retaining ring.
2. Install the material spray tip into the front of the gun block.
3. Install the catalyst tip over the spray tip, using caution not to damage the O-rings on the front of the gun block.
4. Install the retaining ring to secure the catalyst and spray tips in place.
5. Make sure all hose connections are tight.

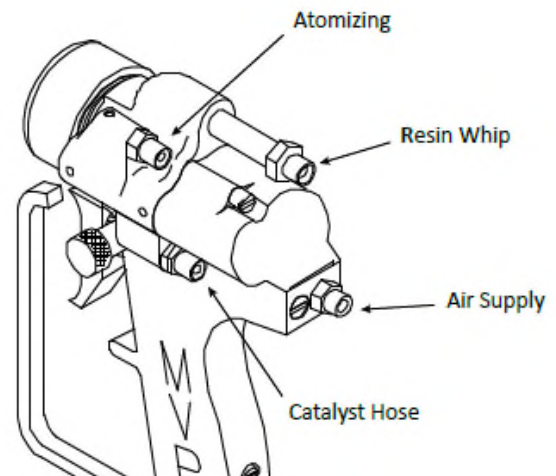

Establish a Fan Pattern

Magnum Venus Products spray equipment provides one of the most efficient methods of quickly applying material to a surface or mold. To make the most of our low-pressure pumping systems and airless internal mix guns, you must understand how to adjust the system for maximum efficiency.

Note ***Because conditions and material vary widely, we cannot provide specific instructions. We do offer guidelines and tests so that you can tune your equipment to meet your specific needs. The basic idea is to use just enough pressure to the powerhead to establish the spray fan and no more.***

6. Lay out a strip of test material such as paper or cardboard.
7. Adjust the main pressure regulator until the operating pressure is 20 psi.

Note **Operating pressure is the air pressure used to operate the resin/catalyst pump. The gauge and regulator are usually labeled “Main Pressure” or “Pump Pressure”.**

8. Moving lengthwise along the test strip, begin spraying a short test fan.
9. If the first test shot had an established fan pattern, flush the gun into an appropriate container, back off the air pressure by 5 psi, then shoot another pattern.
10. Repeat step 9 until the unit no longer produces a fan, then increase the operating pressure until there is just enough to form a soft-looking fan.

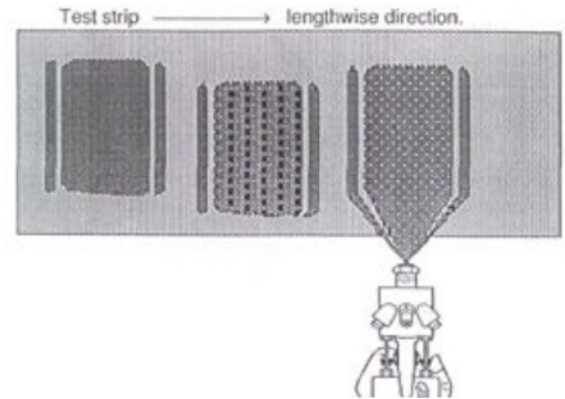

Note **It is unlikely that 20 psi will be sufficient pressure to establish a fan pattern.**

11. If the pressure was not adequate to form a well-defined fan pattern, flush the gun and then increase the main pressure by 5 psi and do another short test spray.
12. Repeat step 11 until a well-defined spray pattern is obtained, then perform step 9 to obtain a soft-looking fan.

Adjust the Fan Pattern

13. Adjust the pattern according to the table below.

Spray Pattern Adjustments			
Illustration	Description	Indicates	Solutions
A	One narrow stream	Operating pressure is very low for the material you are using	Increase the operating pressure
			Increase the material temperature
			Use a smaller nozzle size
B	Three heavy fingers	Horns are beginning to develop, but the operating pressure is still very low	Increase operating pressure
			Increase material temperature
			Use a smaller nozzle size
C	Middle of the stream is wider	Middle of the stream is still not the full width it should be for the nozzle in use	Increase operating pressure
			Increase material temperature

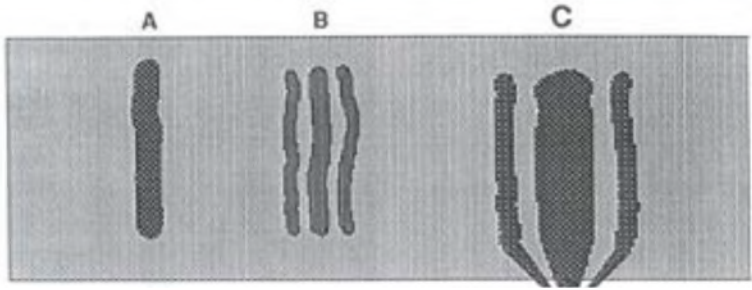
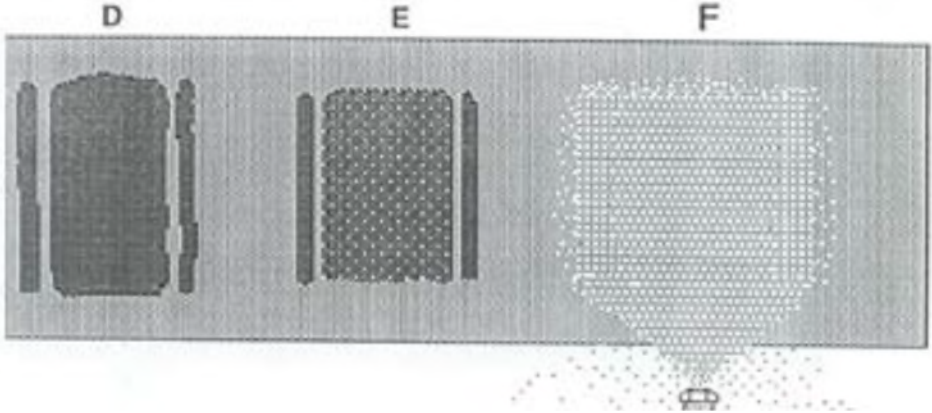
			
Illustration	Description	Indicates	Solutions
D	The pattern is at or near full width	There are well-defined fingers, however there is little or no white frothing (air bubbles) in the center of the sprayed material Note This pattern is usable for an experienced operator	Slightly increase operating pressure
			Slightly increase material temperature
E	The pattern is full width	The fingers are well-defined. A small amount of frothing appears in the sprayed material but disappears in less than 2 minutes	This is considered the best general set of conditions for the fan pattern. Make note of the main pressure and material temperature
F	The pattern is too wide	The fingers are poorly defined. Heavy misting is seen and smelled and there is significant overspray. The heavy white frothing does not disappear within 2 minutes Note This is the most common mistake seen when running MVP equipment	Back off the pressure until the fan pattern fails, then add pressure in 5 psi increments to get the pattern back
			

14. Use the following worksheet to make notes of and track the optimal conditions noted during adjustment.

Spray Fan Test Notes

Material(s) in use:

Catalyst Percentage:

Catalyst Type:

Material is being:

Sprayed

Poured

Other:

This material was successfully applied under the following conditions:

Winter

Spring

Summer

Fall

Air temperature of the factory:

degrees

Relative humidity of the
factory:

%

Other conditions:

Powerhead pressure:

psi

Catalyst accumulator charge:

psi

Resin accumulator charge:

psi

In-line heater setting:

Nozzle size:

Nozzle fan angle:

degrees

Spray Mix Testing

Spray tests are used to fine-tune the adjustments on your MVP dispensing equipment and to check the condition of your hardware and materials.

Note *Using a color-reactive material (material that changes color when catalyzed) makes this testing easier to judge. MVP recommends using a dyed catalyst or a color-reactive material.*

1. Turn the chopper pressure to zero; you should do the spray test without the chop.
2. Lay out a sheet of test material on a flat surface.

Note *The temperature of the surface can affect the reaction time of many chemicals and cause changes in cure times.*

3. Pull the trigger on the gun and begin spraying material along the test strip as shown in the figure below.

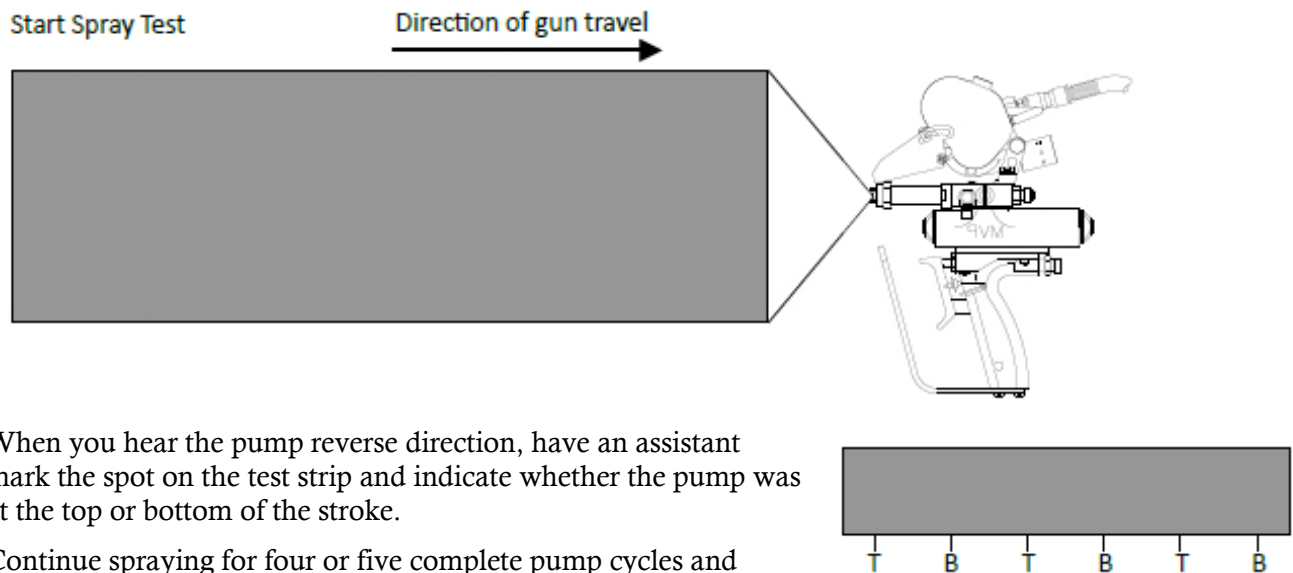

- 4.
5. When you hear the pump reverse direction, have an assistant mark the spot on the test strip and indicate whether the pump was at the top or bottom of the stroke.
6. Continue spraying for four or five complete pump cycles and marking the stroke changes.
7. Use a tongue depressor to test material hardening on several areas of the test strip, making sure to test the top and bottom of the stroke as well as the up and down stroke in several places.
8. Repeat testing several times to determine if any areas are hardening faster or slower than others.

Note *Color-reactive materials will provide a visual indicator of material curing times as well, making this testing easy and accurate.*

9. Make notes to record what is occurring.
10. Pay particular attention to any areas that harden faster or slower than others, indicating a problem.

Interpret Test Results

11. If all areas of the test spray harden at the same time, skip to Performing Daily Tasks.
12. If there are areas with little to no hardening or extremely fast hardening, use the following table to troubleshoot your problem.

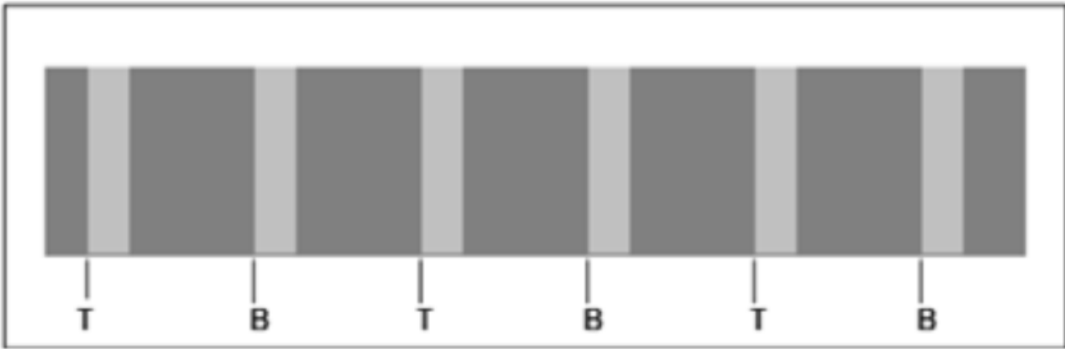
Cure Troubleshooting		
Result	Possible Cause	Solution
Material delivered at the top and bottom of the stroke is not curing or is curing more slowly than the material delivered in the middle of the up and down stroke, indicating low/no catalyst at the top and bottom of the stroke (see below).	There is no or improper accumulation effect in the catalyst system Note This is normally only a problem at high pressures	Check to be sure you are using the proper catalyst hose, with or without core
		Install a catalyst accumulator, if needed
		Check for a restriction in the catalyst system
		
Material delivered at the top and bottom of the stroke is hot (curing very rapidly). Also thin areas of material may be noticeable compared to the volume in the middle of the stroke, indicating low resin at the top and bottom of the stroke (see above).	There is no or improper accumulation effect in the resin system.	Clean resin filter and reinstall.
	Resin accumulator full of hard material or blockage	Clean resin filter and reinstall or replace accumulator.
	Incorrect accumulator installed	Replace accumulator (for chargeable accumulator systems see below)
	Pump pressure is too high	Lower resin pump pressure
Material delivered on the catalyst pump up-stroke (from the bottom to the top) is not curing or slow cure, indicating that no catalyst is being delivered on the up-stroke (see below).	Worn or damaged catalyst piston seal	Replace worn or damaged parts. Refer to the catalyst pump service and repair manual.
	Damaged catalyst pump cylinder	
	Worn or damaged piston body ball	
	Damaged piston body ball seat	

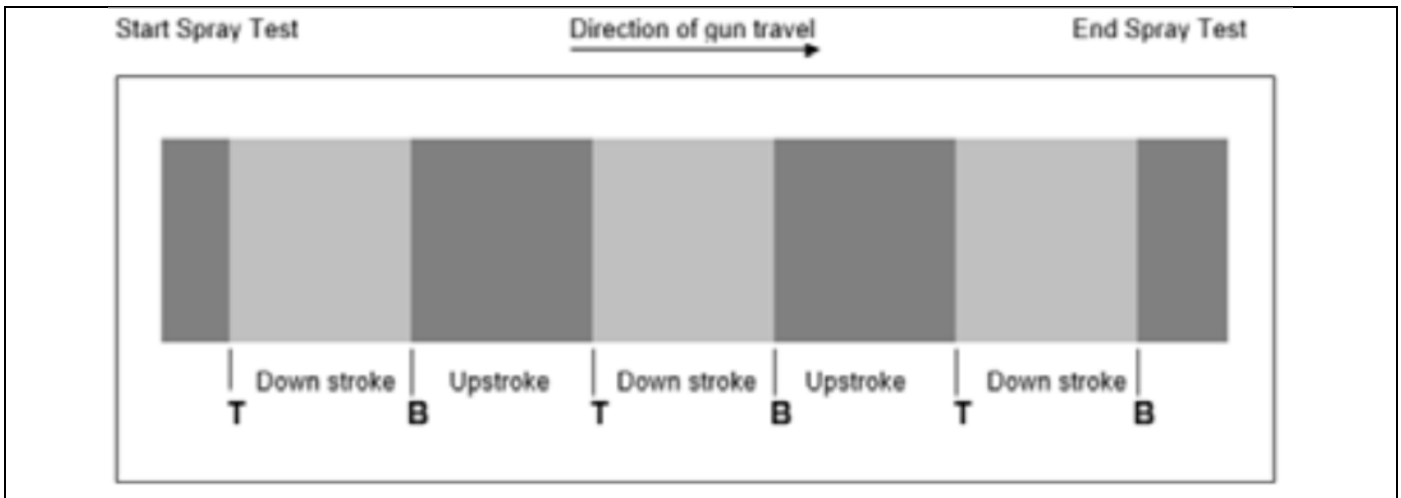

<p>Material delivered on the catalyst pump down-stroke (from the top to the bottom) is not curing or slow cure, indicating no catalyst is being delivered on the down-stroke (see above).</p>	<p>Worn or damaged inlet body</p>	<p>Replace worn or damaged parts. Refer to the catalyst pump service and repair manual.</p>
	<p>Worn or damaged inlet body ball</p>	
<p>Material is delivered with streaks running the length of the test spray. Some strips cure normally, some not at all, others cure at faster or slower rates (see below). This is not a pumping problem, it indicates a mixing problem when the fan is delivering streams of poorly catalyzed resin and/or pure catalyst.</p>	<p>The turbulent mixer is worn, clogged, or damaged in some way.</p>	<p>Shut down the system and inspect the turbulent mixer and mix chamber, then repair or replace parts as needed.</p>
	<p>The mix chamber is scratched or damaged</p>	

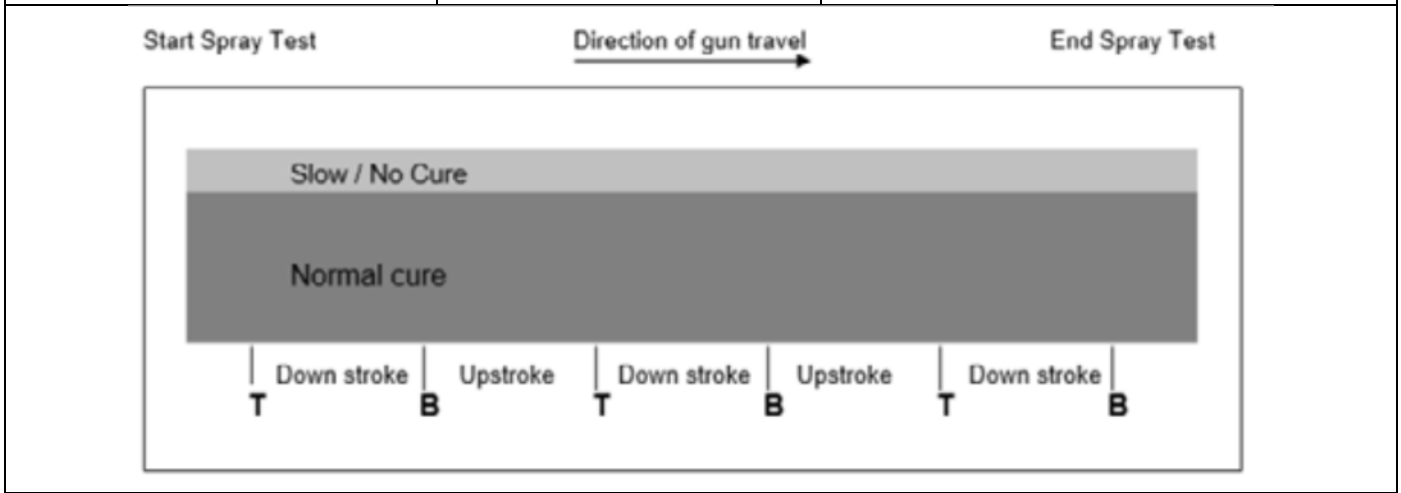

<p>Material delivered at the beginning of the test strip is hot (low in resin), followed immediately by material that is cold (low in catalyst), followed by material that is poorly mixed and cures (see below). This indicates that the system is unbalanced at the beginning of the spray. After a moment the system balances and properly mixed material is delivered.</p>	<p>The catalyst needle on the gun opens before the resin needle.</p>	<p>Adjust the catalyst and resin needles to the proper setting.</p>
--	--	---

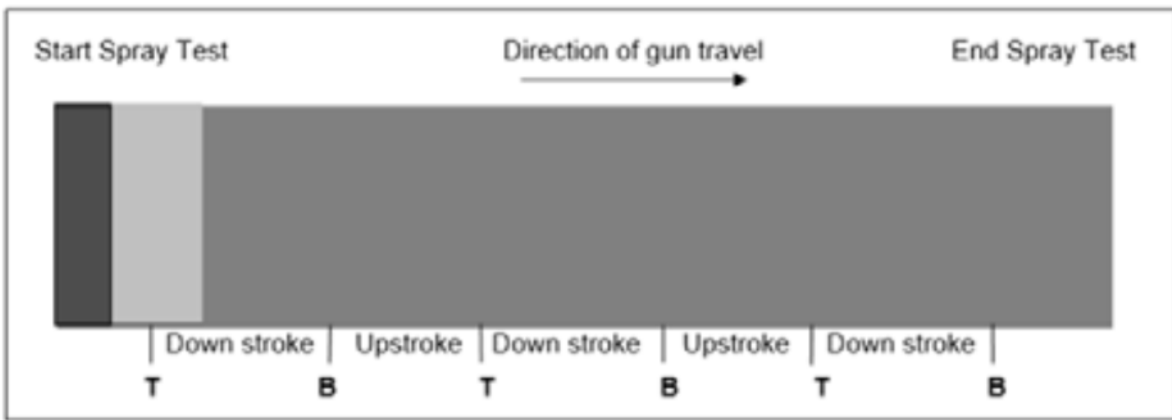

<p>Material delivered at the beginning of the test spray is cold (low catalyst), followed by material that is properly mixed and cures (see below). This indicates that the system is unbalanced at the beginning of the spray.</p>	<p>The resin needle is opening too soon before the catalyst needle, resulting in a shot of pure uncatalyzed resin until the catalyst needle opens.</p>	<p>Adjust the catalyst and resin needles to the proper setting.</p>
---	--	---

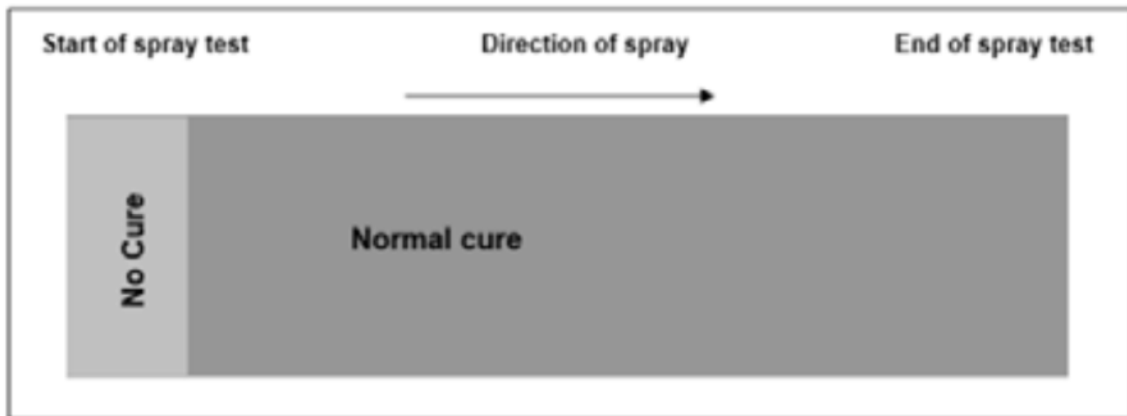

13.

Performing Daily Tasks

There are steps that need to be followed before start-up of the system and steps to begin operations the first time or to restart and shut down the system for day-to-day operations. Perform the appropriate steps for your system in the order given. Use the checklists in this section that are applicable to your system to document that the procedure was performed properly.

If you have an internal mix system, skip to Internal Mix Systems.

External Mix Systems

Before Starting

Note ***Use the External Mix Pre-Start Checklist to document performance of the steps in this section.***

1. Gather all tools and materials needed for pre-start checks.
2. Make sure the incoming airline is ½ inch and is properly connected to the inlet manifold.
3. Make sure the resin container is strapped down properly.
4. Turn the incoming air valve to the open position.
5. Turn the air supply on.
6. Remove the nozzle cap, catalyst tip, and nozzle from the gun.
7. Check for oil in the pump reservoir and fill 1/3 full.
8. Make sure there is an adequate supply of catalyst in the catalyst jug.
9. Check that the catalyst bottle cap and screen are in place.
10. Place the resin pick-up wand in the resin supply container.
11. Place the end of the resin return hose in the resin container.
12. Purge any air from the catalyst feed line to the catalyst pump.
13. Close the ball valve below the surge chamber.
14. If you have previously used the system, skip to step [29](#).

First Time Start Up

Note ***Use the External Mix Initial Start-Up Checklist to document performance of the steps in this section.***

15. Remove the catalyst tip, spray tip, and retaining ring from the front of the gun.
16. Remove the pivot pin from the catalyst pump slave arm.
17. Manually operate the catalyst pump until you see catalyst exiting the front of the gun (leave the pivot pin out).
18. Make sure the ball valve below the surge chamber is closed.
19. Using the regulator on the manifold, slowly turn up the pump pressure until the pump moves slowly and evenly.

20. Turn up the resin pump pressure until air/resin exits the front of the gun.
21. Turn the air to the pump down to zero.
22. Disengage the gun trigger and leave it in the closed position.
23. Clean the front of the gun with acetone.
24. Turn up the pump pressure to 40 psi (2.8 bar).
25. Hand prime the catalyst pump until you feel back pressure.
26. Adjust the catalyst percentage as required for the job.
27. Replace the pivot pin in the catalyst slave drive and lock it in place.
28. Re-install the catalyst tip, spray tip, and retaining ring to the front of the gun.

Daily Start Up

Note ***Use the External Mix Daily Start-Up Checklist to document performance of the steps in this section.***

29. Check all hoses for wear or damage; replace as needed.
30. Check all material supplies and fill or replace as needed.
31. Open the recirculation valve on the catalyst pump.
32. Open the main inlet air valve on the manifold.
33. Remove the pivot pin from the catalyst pump slave drive.
34. Manually pump the catalyst pump until the stream returning to the catalyst jug is air-free.
35. Close the recirculation valve on the catalyst pump.
36. Manually pump the catalyst pump until you feel back pressure.
37. Check the resin pump pressure; if needed, slowly turn the pump air pressure to the operating pressure of 30 – 50 psi (2 – 3.5 bar).

Note ***If a safety override is installed on the unit, press and hold the priming button while adjusting the air pressure.***

38. Replace the pivot pin into the catalyst pump drive.
39. Check the atomizing air pressure and adjust as necessary.
40. Lubricate the nozzle O-rings, stud O-rings, and gun front threads.
41. Install the nozzle and catalyst tip onto the gun.

Daily Shut Down

42. Wipe the face of the nozzle and catalyst tip with solvent.
43. Turn off the main air ball valve on the air manifold.
44. Remove the nozzle and catalyst tip and clean with solvent.
45. Wipe the gun face clean with a rag or brush and solvent.
46. Hang the gun with the gun block exit holes facing downward.



Pro Systems External Mix – Pre-Start Checklist

Activities must be done in the sequence shown and checked off as completed. Use this checklist in conjunction with the operating manual for the Pro Systems External Mix unit.

Order	Activity	✓ When Completed
1	Put on Respirator (as specified for spray painting), Protective Clothing, Eye Protection, and PVC Gloves.	
2	Tools and materials are available for pre-start checks.	
3	Incoming airline is ½ inch.	
4	Incoming airline is connected to the inlet manifold.	
5	Ground straps are connected to the resin drum and to earth.	
6	Incoming air valve is in the OPEN position.	
7	Air supply is ON.	
8	Remove nozzle cap, catalyst tip and nozzle.	
9	Check for oil in the pump reservoir, fill 1/3 full.	
10	Check that there is Catalyst in the Catalyst Bottle.	
11	Check that the Catalyst Bottle Cap and Screen are in place.	
12	Place the Resin Pick-up wand in the resin supply container.	
13	Place the end of the Resin Return Hose in the resin container.	
14	Remove air from the Catalyst feed line to the Catalyst Pump.	
15	Close the ball valve below the Surge Chamber.	

THE UNIT IS NOW READY TO BE STARTED. GO TO PRO SYSTEMS EXTERNAL MIX INITIAL START-UP CHECKLIST.

Note any abnormal conditions observed and corrected

Abnormal Condition	✓ When Corrected

Operator Name: _____ Date: _____

Sign off when pre-start checks are completed: _____



Pro Systems External Mix - Initial Start-Up Checklist

Activities must be done in the sequence shown and checked off as completed. Use this checklist in conjunction with the operating manual for the Pro Systems External Mix unit. Before performing this sequence, you must complete the steps in the Pro Systems External Mix-Pre-Start Checklist.

Order	Activity	✓ When Complete
1	Put on Respirator (as specified for spray painting), Protective Clothing, Eye Protection, and PVC Gloves.	
2	Remove the catalyst tip, spray tip, and retaining ring from the front of the gun.	
3	Remove the pivot pin from the catalyst pump.	
4	Manually pump the catalyst pump. Observe catalyst exiting the front of the gun. Leave the pivot pin out.	
5	Make sure the ball valve below the surge chamber is closed.	
6	Using the regulator on the manifold, slowly turn up the pump air pressure until the pump moves slowly and evenly.	
7	Turn up the air to the resin pump until air/resin exits the front of the gun.	
8	Turn the air to the pump down to zero.	
9	Disengage the gun trigger. Leave in the CLOSED position.	
10	Brush/clean the front of the gun with acetone.	
11	Turn up the pump pressure to 40 psi.	
12	Hand prime the catalyst pump until back pressure builds.	
13	Adjust the catalyst percentage required.	
14	Replace the pivot pin in the catalyst slide drive and lock in place.	
15	Re-install the catalyst tip, spray tip, and retaining ring onto the front of the gun.	

THE UNIT IS NOW READY FOR OPERATIONS.

Note any abnormal conditions observed and corrected

Abnormal Condition	✓ When Corrected

Operator Name: _____ Date: _____

Sign off when start-up checks are completed: _____



Pro Systems External Mix - Daily Start-Up Checklist

Activities must be done in the sequence shown and checked off as completed. Use this checklist in conjunction with the operating manual for the Pro Systems External Mix unit.

Before performing this sequence, you must complete the steps in the Pre-Start Checklist for the unit.

Order	Activity	✓ When Complete
1	Put on Respirator (as specified for spray painting), Protective Clothing, Eye Protection, and PVC Gloves.	
2	Check all hoses for damage.	
3	Check all material supplies and fill or replace as needed.	
4	Open recirculation valve on catalyst manifold.	
5	Open main inlet air valve on the manifold.	
6	Remove the pivot pin from the catalyst drive.	
7	Manually pump the catalyst pump with the catalyst drive; observe catalyst returning to the catalyst jug, pump until the stream is air free.	
8	Close recirculation valve on catalyst manifold.	
9	Manually pump the catalyst pump with the slave arm drive until back pressure builds.	
10	Check resin pump pressure. If needed slowly turn up the pump air pressure to the operating pressure, 30 – 50 psi. If a safety over ride valve is installed press and hold the priming button while adjusting air pressure.	
11	Replace the pivot pin into the catalyst pump drive.	
12	Check atomizing air pressure, adjust as necessary.	
13	Lubricate the nozzle O-rings, stud O-rings and gun front threads.	
14	Install nozzle and catalyst tip onto the gun.	

THE UNIT IS NOW READY FOR USE.

Note any abnormal conditions observed and corrected

Abnormal Condition	✓ When Corrected

Operator Name: _____ Date: _____

Sign off when start-up checks are completed: _____



Pro Systems External Mix - Daily Shutdown Checklist

Activities must be done in the sequence shown and checked off as completed. Use this checklist in conjunction with the operating manual for the Pro Systems External Mix unit.

Order	Activity	✓ When Completed
1	Put on Respirator (as specified for spray painting), Protective Clothing, Eye Protection, and PVC Gloves.	
2	Wipe the face of the nozzle and catalyst tip with solvent.	
3	Turn off the main air ball valve at the air manifold.	
4	Remove the nozzle and catalyst tip and clean with solvent.	
5	Wipe the gun face clean with a rag or brush and solvent.	
6	Hang the gun with the gun block exit holes facing downwards.	

Note any abnormal conditions observed and corrected

Abnormal Condition	✓ When Corrected

Operator Name: _____ Date: _____

Sign off when shutdown checks are complete: _____

Internal Mix Systems

Before Starting

Note ***Use the Internal Mix Pre-Start Checklist to document performance of the steps in this section.***

47. Gather all tools and materials needed for pre-start checks.
48. Make sure the incoming airline is ½ inch and is properly connected to the inlet manifold.
49. Make sure the resin container is strapped down properly.
50. Turn the incoming air valve to the open position.
51. Turn the air supply on.
52. Open the air supply to the gun.
53. Seat the catalyst and resin seals on the gun.
54. Compress the resin pump packing.
55. Make sure there is sufficient catalyst in the catalyst jug.
56. Check that the catalyst bottle cap and screen are in place.
57. Place the resin pick-up wand in the resin supply container.
58. Place the end of the resin return hose in the resin container.
59. Purge any air from the catalyst feed line to the catalyst pump.
60. Close the ball valve below the surge chamber.
61. If you have previously used the system, skip to step [80](#).

First Time Start Up

Note ***Use the Internal Mix Initial Start-Up Checklist to document performance of the steps in this section.***

62. Lock the gun trigger into the open position over an appropriate waste container.
63. Remove the pivot pin from the catalyst pump slave arm.
64. Manually operate the catalyst pump until you see catalyst exiting the front of the gun (leave the pivot pin out).
65. Make sure the ball valve below the surge chamber is closed.
66. Using the regulator on the manifold, slowly turn up the pump pressure until the pump moves slowly and evenly.
67. Turn up the resin pump pressure until air/resin exits the front of the gun.
68. Turn the air to the pump down to zero.
69. Disengage the gun trigger and leave it in the closed position.
70. Flush the mix chamber on the gun with acetone.
71. Turn up the pump pressure to 40 psi (2.8 bar).

72. Hand prime the catalyst pump until you note the pressure rising on the pump pressure gauge.
73. Adjust the catalyst percentage as required for the job.
74. Replace the pivot pin in the catalyst slave drive and lock it in place.
75. Insert the distribution ring into the mix chamber locating rim on the gun.
76. Insert the catalyst injector into the aperture on the distribution ring.
77. Place the resin seal into the mix chamber locating rim.
78. Place the mix chamber and catalyst injector onto the front of the gun and secure it in place with two screws.
79. Flush the assembled mix chamber with solvent.

Daily Start Up

Note ***Use the Internal Mix Daily Start-Up Checklist to document performance of the steps in this section.***

80. Check all hoses for wear or damage; replace as needed.
81. Check all material supplies and fill or replace as needed.
82. Open the main inlet air valve on the manifold.
83. Open the 3-way ball valve to the dump side.
84. Remove the pivot pin from the catalyst pump slave drive.
85. Manually pump the catalyst pump until the stream returning to the catalyst jug is air-free.
86. Close the 3-way dump valve.
87. Manually pump the catalyst pump until you reach operating pressure of 100 -200 psi (7 – 14 bar).
88. Replace the pivot pin into the catalyst pump drive, adjusting the catalyst percentage as required.
89. Check the resin pump pressure; if needed, slowly turn the pump air pressure to the operating pressure of 30 – 50 psi (2 – 3.5 bar).

Note ***If a safety override is installed on the unit, press and hold the priming button while adjusting the air pressure.***

90. Insert the distribution ring into the mix chamber locating rim.
91. Place the mix housing seal into the mix chamber locating rim.
92. Insert the catalyst injector and injector seal into the aperture in the distribution ring (the spring goes into the gun block).
93. Place the mix chamber and catalyst injector onto the front of the gun and secure in place with two screws.
94. Flush the assembled mix chamber with solvent.
95. Install the mixer and nozzle onto the mix chamber.

Daily Shut Down

Note ***Use the Internal Mix Daily Shutdown Checklist to document performance of the steps in this section.***

96. Flush the gun with solvent.
97. Wipe the face of the nozzle.
98. Turn off the main air ball valve at the air intake.
99. Release the solvent flush tank pressure.
100. Remove the nozzle and clean with solvent.
101. Remove the mix housing and clean it.
102. Wipe the gun block face with a clean rag.
103. Hang the gun with the gun block exit holes facing upward.



Pro Systems Internal Mix – Pre-Start Checklist

Activities must be done in the sequence shown and checked off as completed. Use this checklist in conjunction with the operating manual for the Pro Systems Internal Mix unit.

Order	Activity	✓ When Completed
1	Put on Respirator (as specified for spray painting), Protective Clothing, Eye Protection, and PVC Gloves.	
2	Tools and materials are available for pre-start checks.	
3	Incoming airline is ½ inch.	
4	Incoming airline is connected to the inlet manifold.	
5	Ground straps are connected to the resin drum and to earth.	
6	Incoming air valve is in the OPEN position.	
7	Air supply is ON.	
8	At the air manifold, open the air supply to the gun.	
9	Seat the catalyst and resin seals on the gun.	
10	Compress the resin pump packing.	
11	Check for oil in the pump reservoir.	
12	Adjust the catalyst pump packing nut.	
13	Check that there is catalyst in the catalyst jug.	
14	Check that the catalyst bottle cap is in place.	
15	Place the resin pick-up wand in the resin supply container.	
16	Place the end of the resin return hose in the resin container.	
17	Fill the solvent flush tank.	
18	At the manifold, turn the air pressure on to the solvent flush tank to 60 psi.	
19	Flush the mix chamber on the gun.	
20	Remove air from the catalyst feed line to the catalyst pump.	
21	Close the ball valve below the surge chamber.	

THE UNIT IS NOW READY TO BE STARTED. GO TO PRO SYSTEMS INTERNAL MIX INITIAL START-UP CHECKLIST.

Note any abnormal conditions observed and corrected

Abnormal Condition	✓ When Corrected

Operators Name: _____ **Date:** _____

Sign off when pre-start checks are completed: _____



Pro Systems Internal Mix - Initial Start-Up Checklist

Activities must be done in the sequence shown and checked off as completed. Use this checklist in conjunction with the operating manual for the Pro Systems Internal Mix unit.

Before performing this sequence, you must complete the steps in the Pre-Start Checklist for the unit.

Order	Activity	✓ When Complete
1	Put on Respirator (as specified for spray painting), Protective Clothing, Eye Protection, and PVC Gloves.	
2	Lock the gun trigger in an open position over an appropriate container.	
3	Remove the pivot pin from the catalyst pump drive.	
4	Manually pump the catalyst pump, observe catalyst exiting the mix chamber on the gun. Leave the pivot pin out.	
5	Make sure the ball valve below the surge chamber is closed.	
6	Using the regulator on the manifold, slowly turn up the pump air pressure until the pump moves slowly and evenly.	
7	Turn up the air to the resin pump until air/resin exits the mix chamber to the gun.	
8	Turn the air to the pump down to zero.	
9	Disengage the gun trigger and leave it in the CLOSED position.	
10	Flush the mix chamber of the gun with acetone.	
11	Turn up the pump pressure to 40 psi.	
12	Hand prime the catalyst pump until the pressure rises on the gauge.	
13	Replace the pivot pin in the catalyst slave drive and lock it in place.	
14	Adjust the catalyst percentage to the required setting.	
15	Insert the distribution ring into the mix chamber locating rim on the gun.	
16	Insert the catalyst injector into her aperture in the distribution ring.	
17	Place the resin seal into the mix chamber locating rim.	
18	Place the mix chamber and catalyst injector onto the front of the gun and secure with 2 screws.	
19	Flush the assembled mix chamber with solvent.	

THE UNIT IS NOW READY FOR USE.

Note any abnormal conditions observed and corrected

Abnormal Condition	✓ When Corrected

Operator Name: _____ Date: _____

Sign off when start-up checks are completed: _____



Pro Systems Internal Mix - Daily Start-Up Checklist

Activities must be done in the sequence shown and checked off as completed. Use this checklist in conjunction with the operating manual for the Pro Systems Internal Mix unit. Before performing this sequence, you must complete the steps in the Pre-Start Checklist for the unit.

Order	Activity	✓ When Complete
1	Put on Respirator (as specified for spray painting), Protective Clothing, Eye Protection, and PVC Gloves.	
2	Check all hoses for damage.	
3	Check all material supplies and fill or replace as needed.	
4	Open the main inlet air valve on the manifold.	
5	Open the 3-way ball valve to the dump side.	
6	Remove the pivot pin from the catalyst drive.	
7	Manually pump the catalyst pump with the catalyst drive; observe catalyst returning to the catalyst jug, pump until the stream is air free.	
8	Close the 3-way ball valve.	
9	Manually pump the catalyst pump with the slave arm drive to operating pressure 100 – 200 psi.	
11	Replace the pivot pin into the catalyst pump drive.	
12	Adjust the catalyst percentage as required.	
13	Check the pump air regulator and gauge. If needed, use the regulator on the air manifold to slowly turn up the pump air pressure to operating pressure of 30 – 50 psi. Note <i>If a safety override valve is installed, press and hold the priming button while adjusting air pressure.</i>	
14	Insert the distribution ring into the mix chamber locating rim.	
15	Place the mix housing seal into the mix chamber locating rim.	
16	Insert the catalyst injector and injector seal into the aperture in the distribution ring and the spring into the gun block.	
17	Place the mix chamber and catalyst injector onto the front of the gun and secure it with 2 screws.	
18	Flush the assembled mix chamber with solvent.	
19	Install the mixer and nozzle onto the mix chamber.	

Note any abnormal conditions observed and corrected

Abnormal Condition	✓ When Corrected

Operator Name: _____ Date: _____

Sign off when start-up checks are completed: _____



Pro Systems Internal Mix - Daily Shutdown Checklist

Activities must be done in the sequence shown and checked off as completed. Use this checklist in conjunction with the operating manual for the Pro Systems Internal Mix unit.

Order	Activity	✓ When Completed
1	Put on Respirator (as specified for spray painting), Protective Clothing, Eye Protection, and PVC Gloves.	
2	Flush the gun with solvent.	
3	Wipe the face of the nozzle after flushing.	
4	Turn off the air ball valve at the air intake.	
5	Release the solvent flush tank pressure.	
6	Remove the nozzle and clean it.	
7	Remove the mix housing and clean it.	
8	Wipe the gun block face with a clean rag.	
9	Hang the gun with the gun block exit holes facing upward.	

Note any abnormal conditions observed and corrected

Abnormal Condition	✓ When Corrected

Operator Name: _____ Date: _____

Sign off when shutdown checks are complete: _____

Troubleshooting



WARNING

Fluids are under high pressure. Before performing any service or repair on this equipment, relieve air and fluid pressure.

The most common problems with the equipment can be diagnosed by analyzing the cured part. Use the table below to troubleshoot issues.

System Troubleshooting		
Symptom	Possible Cause	Remedy
Slow cure during upstroke	S.S. ball in catalyst pump piston body not seating	Clean ball and inspect seat. Replace ball, piston seal, or piston body as applicable.
Slow cure during downstroke	S.S. ball in catalyst pump inlet body not seating	Clean ball and inspect seat. Replace ball or have seat repaired if questionable.
	Catalyst check valve is not working correctly	Inspect the catalyst check valve and repair or replace as needed
No cure or slow overall cure	Catalyst pump set at too low or too high a percentage	Move the catalyst pump to an appropriate setting. Verify the pump is in a vertical position.
	Catalyst supply is lower than the outlet fitting on the jug	Fill the catalyst jug 1/3 full.
	Quick pin not attached to pump or slave arm	Install the quick pin, making sure the catalyst pump is in a vertical position.
	Catalyst leaking	Check all fittings. The catalyst system must be fluid tight
	Catalyst relief valve on catalyst pump is leaking	Relieve pressure from the pro pump. Clean and repair the relief valve
	Catalyst suction screen in the catalyst jug is clogged	Clean the suction screen and verify catalyst supply is not contaminated
	Air lock in catalyst pump	Remove air lock
	Catalyst pump piston seal worn or damaged	Replace piston seal (spring in seal faces top of pump)
	Catalyst pump outlet body damaged	Replace catalyst pump outlet body and piston seal. During reassembly, verify spring in seal faces top of pump and the pump is reconnected vertically
	Catalyst pump check valve blocked or stuck	Disassemble check valve and remove blockage.
	Catalyst hose plugged	Relieve pressure from the system and then replace catalyst hose
Material too cold	Consult your material supplier for proper temperature. Maintain a draft-free environment of about 70 degrees F. An auxiliary heat source may be required to reduce gel time.	

	Piston cups, piston ball, or pump cylinder worn	Clean and inspect parts; replace any damaged components.
Low output on upstroke of pro pump	Clogged pump pick-up wand screen	Unscrew screen from hose and clean
No fan, constant low output, or fast cure	Resin filter clogged	Disassemble and clean filter body and screen with solvent Disassemble and clean the resin filter
	Resin hose plugged	Relieve pressure from system and then flush the hose with solvent. If material is hard, replace hose.
	Leaking pick-up wand assembly	Tighten assembly fittings
	Material cold or air pressure low	Heat material or increase pump pressure
Narrow fan	Material cold	Heat material
	Nozzle too large	Switch to a smaller nozzle
	Air pressure low	Increase pump pressure (as a last resort)
	Resin filter clogged	Disassemble and clean the resin filter
Wide fan	Air pressure too high	Lower pressure then increase pressure to the desired fan
	Nozzle too small or too wide	Change the nozzle
Round fan	Orifice in nozzle worn, clogged, or damaged	Insert a thin wire through the rear face of the nozzle orifice. Clean material from the V shaped notch in front. If the notch is rough or worn, replace the nozzle. Soak off hardened material in solvent.
	Air-assist pressure too high	Decrease air-assist pressure
Excessive misting	Pump air pressure too high	Reduce air pressure to the material pump
Heavy pulsation	Resin accumulator plugged	Relieve pressure from the system then disassemble and clean the accumulator
Pump jumps on upstroke	Piston ball worn or not seating properly	Replace piston ball and piston cups. Be sure to lubricate ball and cups thoroughly.
Pump dives on downstroke	Foot valve, spring retainer, or foot valve ball damaged or dirty	Clean or replace parts as applicable. Be sure to lubricate ball thoroughly.
	Pick-up wand assembly not tight	Tighten or seal joints of pick-up wand
	Air in material	Agitate material to remove air pockets
Low output on upstroke	Piston cups, piston ball, or pump cylinder worn	Inspect and clean the parts; replace as applicable
Pump does not run	Silencers on valve block plugged	Turn off air to pump and unscrew silencers, then clean silencers and reinstall
	Actuator valve or socket cap screw at shift block broken	Replace the broken cartridge valve or socket cap screw

	Pro pump or hose plugged	Relieve fluid pressure from the system, then disassemble and clean the pro pump. Replace any worn parts. Rep
	Air not connected	Check that air hose is connected to manifold and regulator is at 20 psi or more
	Air restricted	Straighten any kinks in air hoses
Material in oil reservoir	Packing worn	Replace packing set in lower part of pump
	Piston rod worn or scored	Replace piston rod
No material delivery on downstroke	Foot valve, spring retainer, or foot valve ball damaged or dirty	Clean or replace parts as needed
Hose leaks at fittings	Fitting loose	Tighten fitting. Always check all fittings before operating
	Fitting or nipple damaged	Relieve fluid pressure from the system before attempting to inspect and replace damaged parts
	Crimped hose	Relieve fluid pressure from the system before attempting to inspect and replace damaged parts. If the hose has been sharply bent, the plastic liner may be ruptured and hose should be replaced
Slow cure on one side of fan	Turbulent mixer clogged or damaged	Clean or replace parts as needed
	Distribution ring partly clogged	Remove the mix chamber and clean the distribution ring
	Mix housing damaged	Inspect and replace as needed
Fingers, or heavy lines, in the spray fan	Material too cold	Increase material temperature. Use an in-line resin heater if possible.
	Pump air pressure too low	Slowly increase the pump pressure by 5 psi (0.5 bar) increments and check spray fan each time
	Air-assist pressure it too low	Slowly increase air-assist as needed
Pump has short travel – stuttering near top or bottom of stroke	Valve block is not shifting all the way or is shifting before completing a full stroke	Check air supply to shift block; it should be 90 – 100 psi (6 – 7 bar)
		Replace actuator valve or VPRO-2003 valve as needed.

Troubleshooting for AT Guns

Gun Troubleshooting		
Symptom	Possible Cause	Remedy
Air leaking from exhaust port on back handle while trigger is OFF	O-ring material worn or cut	Replace O-rings
	O-rings on catalyst piston worn or cut	
	O-rings on trigger valve worn or cut	

Air leaking from exhaust port on back of handle while trigger is OFF or ON	O-rings on trigger valve worn or cut	Replace O-rings
	O-rings on catalyst valve and/or material piston worn or nicked	
Catalyst leaking from catalyst tip while gun is not being triggered	O-rings on catalyst valve worn or cut	Replace O-rings
Catalyst leaking from weep hole on catalyst side of gun	O-rings on catalyst valve worn or cut	Replace O-rings
No catalyst coming from gun	Catalyst air piston not actuating	Check for clogged catalyst air passages (small holes underneath back cylinder) Note There is more than one passageway from holes
	Plugged catalyst restrictor (hex head screw with orifice located in front of catalyst valve)	Clean and clear orifice in front of catalyst valve
	Plugged catalyst passageway in head of gun or catalyst tips	Inspect, clean, and clear passageways
	No catalyst flow to gun	See Slave Pump Troubleshooting
Material leaking from tip on front of gun	Loose diffuser seat	Tighten diffuser seat ¼ to ½ turn. Do not overtighten
	Worn needle and/or seat	Replace parts as needed
	O-ring on diffuser nicked or cut	Replace O-rings
Material leaking from weep hole on material side of gun	Loose diffuser seat	Adjust diffuser seat until snug, then tighten ¼ to ½ turn more. Do not overtighten
	Worn needle packing	Replace packing and adjust as indicated above

Clearing Catalyst Pump Air Lock

An air lock is an air bubble in the catalyst pump that prevent catalyst flow. The piston body moves inside the bubble of air instead of pumping catalyst. If you determine that there is an air lock in your catalyst pump and your system has the PRO-RECIRC option, simply open the recirculation valve and hand prime catalyst back to the jug until there is a bubble-free flow, then return the recirculation valve to flow out of the gun. If you do not have the PRO-RECIRC option installed, follow these steps:



WARNING

Fluids are under high pressure. Before performing any service or repair on this equipment, relieve air and fluid pressure.

1. Lock the gun open over an empty container and leave in this position.
2. Relieve pressure from the catalyst pump.

3. Place a rag over the catalyst hose and fitting, then loosen and remove the catalyst hose from the nipple on the catalyst pump.
4. Remove the quick pin from the catalyst bearing block and upper slave arm.
5. Tilt the pump toward the resin pump and watch for the bubble to appear in the inlet tube.
6. If the bubble does not appear, remove the lower quick pin and turn the pump upside down.
7. After releasing the air bubble, slowly hand pump the catalyst into a suitable container until catalyst spurts from the nipple an equal amount on both the upstroke and downstroke.
8. Reconnect the catalyst hose to the nipple.
9. Hand pump the catalyst pump until catalyst comes out of the gun.
10. Install the pump and quick pin back into the slave arm.
11. Close the gun.