

Patriot Metering Pump

Component Manual

This manual is applicable to the following models:

- PAT-CP-1530
- PAT-CP-1530-ADH
- PAT-CP-1530-S
- PAT-CP2-1530
- PAT-CP2-1530
- PAT-CP-3000
- PAT-CP-3000-ADH
- PAT-CP2-3000
- PAT-CP2-3000-ADH

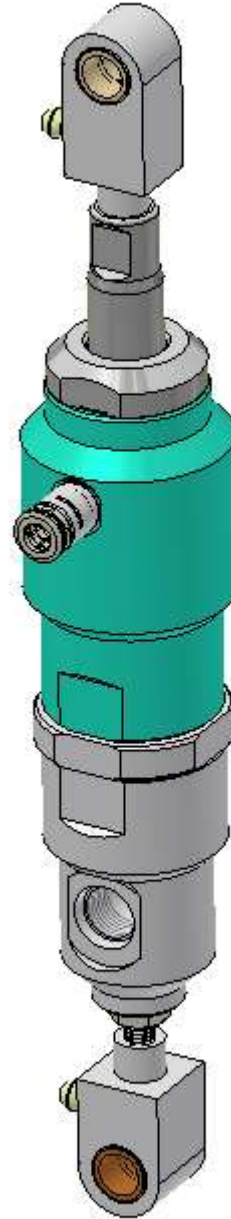



Magnum Industries Europe Ltd. t/a Magnum Venus Products

Official Distributor of MVP Range in the United Kingdom and Ireland

Unit 22a, Navigation Drive, Hurst Business Park,
Brierley Hill, West Midlands, DY5 1UT, UK.

phone: +44 (0)1384 486222
email: info@mvpeurope.co.uk
website: www.mvpeurope.co.uk

Table of Contents

Section	Page
• Table of Contents	3
• Safety & Warning Information	4
• Introduction	15
• Removing Pump	16
• Disassembling Pump	17
• Reassembling Pump	18
• Parts Drawings	19

Safety & Warning Information

Warnings

Due to the vast number of chemicals that could be used and their varying chemical reactions, the buyer and user of this equipment should determine all factors relating to the fluids used, including any of the potential hazards involved. Particular inquiry and investigation should be made into potential dangers relating to toxic fumes, fires, explosions, reaction times, and exposure of human beings to the individual components or their resultant mixtures. MVP assumes no responsibility for loss, damage, expense or claims for bodily injury or property damage, direct or consequential, arising from the use of such chemical components.

The end user is responsible for ensuring that the end product or system complies with all the relevant laws in the country where it is to be used and that all documentation is adhered to.

Recommended Occupational Safety & Health Act (OSHA) Documentation:

- 1910.94 Pertaining to ventilation
- 1910.106 Pertaining to flammable liquids
- 1910.107 Pertaining to spray finishing operations, particularly paragraph (m), Organic Peroxides and Dual Component Coatings

For Additional information, contact the Occupational Safety and Health Administration (OSHA) at <https://www.osha.gov/about.html>.

Recommended National Fire Protection Association (NFPA) Documentation:

- NFPA No.33 Chapter 14 Organic Peroxides and Dual Component Materials
- NFPA No. 63 Dust Explosion Prevention
- NFPA No. 70 National Electrical Code
- NFPA No. 77 Static Electricity
- NFPA No. 91 Blower and Exhaust System
- NFPA No. 654 Plastics Industry Dust Hazards

Fire Extinguisher – code ABC, rating number 4a60bc using Extinguishing Media –Foam, Carbon Dioxide, Dry Chemical, Water Fog, is recommended for this product and applications.

The following general warnings and guidelines are for the setup, use, grounding, maintenance, and repair of equipment. Additional product-specific warnings may be found throughout this manual as applicable. Please contact your nearest MVP Technical Service Representative if additional information is needed.

Safety Precautions

- Avoid skin contact and inhalation of all chemicals.
- Review Material Safety Data Sheet (MSDS) to promote the safe handling of chemicals in use.
- Restrict the use of all chemicals to designated areas with good ventilation.
- Chemicals are flammable and reactive.
- Noxious fumes released when combusted.
- Operate equipment in a ventilated environment only.
- Uncured liquid resins are highly flammable unless specifically labeled otherwise.
- Cured laminate, accumulations of overspray, and laminate sandings are highly combustible.
- Do not operate or move electrical equipment when flammable fumes are present.
- Ground all equipment.
- If a spark is seen or felt, immediately halt operation. Do not operate the equipment until the issue has been identified and repaired.
- Contaminated catalyst may cause fire or explosion.
- Containers may explode if exposed to fire / heat.
- Use and store chemicals away from heat, flames, and sparks.
- Do not smoke in work areas or near stored chemicals.
- Do not mix Methyl Ethyl Ketone Peroxide (MEKP) with materials other than polyethylene.
- Do not dilute MEKP.
- Keep food and drink away from work area.



Physical Hazards

- Never look directly into the spray gun fluid tip. Serious injury or death can result.
- Never aim the spray gun at or near another person. Serious injury or death can result.
- Chemical compounds can be severely irritating to the eyes and skin.
- Inhalation, ingestion, or injection may damage internal organs and lead to pulmonary disorders, cancers, lymphomas, and other diseases or health conditions.
- Other potential health effects include: irritation of the eyes and upper respiratory tract, headache, light-headedness, dizziness, confusion, drowsiness, nausea, vomiting, and occasionally abdominal pain.
- Eye contact: Immediately flush with water for at least 15 minutes and seek immediate medical attention.
- Skin Contact: Immediately wash with soap and water and seek immediate medical attention.
- Inhalation: Move the person to fresh air and seek immediate medical attention.
- Do not remove shields, covers, or safety features on equipment that is in use.
- Never place fingers, hands, or any body part near or directly in front of the spray gun fluid tip. The force of the liquid as it exits the spray tip can shoot liquid through the skin.
- Keep hands and body parts away from any moving equipment or components.
- Do not stand under plunger
- An improperly loaded drum may lead to an imbalance, causing a unit to tip over

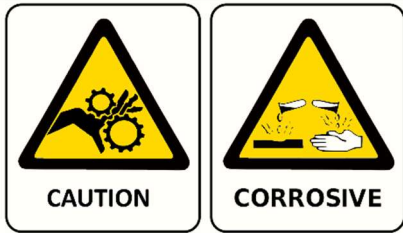

Personal Protective Equipment (PPE)

- MVP recommends the use of personal safety equipment with all products in our catalog.
- Wear safety goggles, hearing protection, a respirator, and chemical resistant gloves.
- Wear long sleeve shirts or jackets and pants to minimize skin exposure.
- PPE should be worn by operators and service technicians to reduce the risk of injury.



For Additional information, contact the Occupational Safety and Health Administration (OSHA). <https://www.osha.gov/about.html>

Symbol Definitions



Indicates the risk of contact with chemicals that are hazardous, which may lead to injury or death.



Indicates the risk of contact with voltage / amperage that may lead to serious injury or death.



Indicates that the materials being used are susceptible to combustion.



Indicates the risk of contact with moving components that may lead to serious injury or death.



Indicates that the system or component should be grounded before proceeding with use or repair.



Indicates the use of lit cigarettes or cigars is prohibited, because the materials being used are susceptible to combustion.



Indicates that the materials and/or the process being performed can lead to ignition and explosion.



A recommendation for the use of Personal Protective Equipment (PPE) before using or repairing the product.

Polymer Matrix Materials: Advanced Composites

Potential health hazards associated with the use of advanced composites can be controlled through the implementation of an effective industrial hygiene and safety program.

https://www.osha.gov/dts/osta/otm/otm_iii/otm_iii_1.html#t_iii:1_1

Resins		
Composite Component	Organ System Target (Possible Target)	Known (Possible) Health Effect
Epoxy resins	Skin, lungs, eyes	Contact and allergic dermatitis, conjunctivitis
Polyurethane resins	Lungs, skin, eyes	Respiratory sensitization, contact dermatitis, conjunctivitis
Phenol formaldehyde	Skin, lungs, eyes	As above (potential carcinogen)
Bismaleimides (BMI)	Skin, lungs, eyes	As above (potential carcinogen)
Polyamides	Skin, lungs, eyes	As above (potential carcinogen)
Reinforcing materials		
Composite Component	Organ System Target (Possible Target)	Known (Possible) Health Effect
Aramid fibers	Skin (lungs)	Skin and respiratory irritation, contact dermatitis (chronic interstitial lung disease)
Carbon/graphite fibers	Skin (lungs)	As noted for aramid fibers
Glass fibers (continuous filament)	Skin (lungs)	As noted for aramid fibers
Hardeners and curing agents		
Composite Component	Organ System Target (Possible Target)	Known (Possible) Health Effect
Diaminodiphenylsulfone	N/A	No known effects with workplace exposure
Methylenedianiline	Liver, skin	Hepatotoxicity, suspect human carcinogen
Other aromatic amines		
Composite Component	Organ System Target (Possible Target)	Known (Possible) Health Effect
Meta-phenylenediamine (MPDA)	Liver, skin (kidney, bladder)	Hepatitis, contact dermatitis (kidney and bladder cancer)
Aliphatic and cyclo-aliphatic amines	Eyes, skin	Severe irritation, contact dermatitis
Polyaminoamide	Eyes, skin	Irritation (sensitization)
Anhydride	Eyes, lungs, skin	Severe eye and skin irritation, respiratory sensitization, contact dermatitis

Catalyst - Methyl Ethyl Ketone Peroxide (MEKP)

MEKP is among the more hazardous materials found in commercial channels. The safe handling of the “unstable (reactive)” chemicals presents a definite challenge to the plastics industry. The highly reactive property which makes MEKP valuable to the plastics industry in producing the curing reaction of polyester resins also produces the hazards which require great care and caution in its storage, transportation, handling, processing and disposal. MEKP is a single chemical. Various polymeric forms may exist which are more or less hazardous with respect to each other. These differences may arise not only from different molecular structures (all are, nevertheless, called “MEKP”) and from possible trace impurities left from the manufacture of the chemicals, but may also arise by contamination of MEKP with other materials in its storage or use. Even a small amount of contamination with acetone, for instance, may produce an extremely shock-sensitive and explosive compound.



WARNING

Contamination with promoters, materials containing promoters (such as laminate sandings), or with any readily oxidizing material (such as brass or iron) will cause exothermic redox reactions which can be explosive in nature. Heat applied to MEKP or heat buildup from contamination reactions can cause the material to reach its Self-Accelerating Decomposition Temperature (SADT).

Researchers have reported measuring pressure rates-of-rise well over 100,000 psi per second when certain MEKP's reach their SADT. For comparison, the highest-pressure rate-of-rise listed in NFPA Bulletin NO.68, “Explosion Venting”, is 12,000 psi per second for an explosion of 12% acetylene and air. The maximum value listed for a hydrogen explosion is 10,000 psi per second. Some forms of MEKP, if allowed to reach their SADT, will burst even an open topped container. This suggests that it is not possible to design a relief valve to vent this order of magnitude of pressure rate-of-rise. The user should be aware that any closed container, be it a pressure vessel, surge chamber, or pressure accumulator, could explode under certain conditions. There is no engineering substitute for care by the user in handling organic peroxide catalysts. If, at any time, the pressure relieve valve on top of the catalyst tank should vent, the area should be evacuated at once and the fire department called. The venting could be the first indication of a heat, and therefore, pressure build-up that could eventually lead to an explosion. Moreover, if a catalyst tank is sufficiently full when the pressure relief valve vents, some catalyst may spray out, which could cause eye injury. For this reason, and many others, anyone whose job puts them in an area where this vented spray might go, should always wear full eye protection even when laminating operations are not taking place.

Safety in handling MEKP depends to a great extent on employee education, proper safety instructions, and safe use of the chemicals and equipment. Workers should be thoroughly informed of the hazards that may result from improper handling of MEKP, especially regarding contamination, heat, friction and impact. They should be thoroughly instructed regarding the proper action to be taken in the storage, use, and disposal of MEKP and other hazardous materials used in the laminating operation. In addition, users should make every effort to:

- Store MEKP in a cool, dry place in original containers away from direct sunlight and away from other chemicals.
- Keep MEKP away from heat, sparks, and open flames.
- Prevent contamination or MEKP with other materials, including polyester over spray and sandings, polymerization accelerators and promoters, brass, aluminum, and non-stainless steels.

- Never add MEKP to anything that is hot, since explosive decomposition may result.
- Avoid contact with skin, eyes, and clothing. Protective equipment should be worn at all times. During clean-up of spilled MEKP, personal safety equipment, gloves, and eye protection must be worn. Firefighting equipment should be at hand and ready.
- Avoid spillage, which can heat up to the point of self-ignition.
- Repair any leaks discovered in the catalyst system immediately, and clean-up the leaked catalyst at once in accordance with the catalyst manufacturer's instructions.
- Use only original equipment or equivalent parts from Magnum Venus Products in the catalyst system (i.e.: hoses, fitting, etc.) because a dangerous chemical reaction may result between substituted parts and MEKP.
- Catalyst accumulated from the purging of hoses or the measurement of fluid output deliveries should never be returned to the supply tank, such catalyst should be diluted with copious quantities of clean water and disposed of in accordance with the catalyst manufacturer's instructions.

The extent to which the user is successful in accomplishing these ends and any additional recommendations by the catalyst manufacturer determines largely the safety that will be present in his operation.

Clean-Up Solvents and Resin Diluents



WARNING

A hazardous situation may be present in your pressurized fluid system! Hydro carbon solvents can cause an explosion when used with aluminum or galvanized components in a closed (pressurized) fluid system (pump, heaters, filters, valves, spray guns, tanks, etc.). An explosion could cause serious injury, death, and/or substantial property damage. Cleaning agents, coatings, paints, etc. may contain Halogenated Hydrocarbon solvents. Some Magnum Venus Products spray equipment includes aluminum or galvanized components and will be affected by Halogenated Hydrocarbon solvents.

There are three key elements to the Halogenated Hyrdocarbon (HHC) solvent hazard.

- | | | |
|----|---|--|
| 1. | The presence of HHC solvents. | 1,1,1 – Trichloroethane and Methylene Chloride are the most common of these solvents. However, other HHC solvents are suspect if used; either as part of paint or adhesives formulation, or for clean-up flushing. |
| 2. | Aluminum or Galvanized Parts. | Most handling equipment contains these elements. In contact with these metals, HHC solvents could generate a corrosive reaction of a catalytic nature. |
| 3. | Equipment capable of withstanding pressure. | When HHC solvent contact aluminum or galvanized parts inside a closed container such as a pump, spray gun, or fluid handling system, the chemical reaction can, over time, result in a build-up of heat and pressure, which can reach explosive proportions. When all three elements are present, the result can be an extremely violent explosion. The reaction can be sustained with very little aluminum or galvanized metal; any amount of aluminum is too much. |

- The reaction is unpredictable. Prior use of an HHC solvent without incident (corrosion or explosion) does NOT mean that such use is safe. These solvents can be dangerous alone (as a clean-up or flushing agent) or when used as a component or a coating material. There is no known inhibitor that is effective under all circumstances. Mixing HHC solvents with other materials or solvents such as MEKP, alcohol, or toluene may render the inhibitors ineffective.
- The use of reclaimed solvents is particularly hazardous. Reclaimers may not add any inhibitors. The possible presence of water in reclaimed solvents could also feed the reaction.
- Anodized or other oxide coatings cannot be relied upon to prevent the explosive reaction. Such coatings can be worn, cracked, scratched, or too thin to prevent contact. There is no known way to make oxide coatings or to employ aluminum alloys to safely prevent the chemical reaction under all circumstances.
- Several solvent suppliers have recently begun promoting HHC solvents for use in coating systems. The increasing use of HHC solvents is increasing the risk. Because of their exemption from many state implementation plans as Volatile Organic Compounds (VOCs), their low flammability hazard, and their not being classified as toxic or carcinogenic substances, HHC solvents are very desirable in many respects.



WARNING

Do not use Halogenated Hydrocarbon (HHC) solvents in pressurized fluid systems having aluminum or galvanized wetted parts.

Magnum Venus Products is aware of NO stabilizers available to prevent HHC solvents from reaction under all conditions with aluminum components in closed fluid systems. HHC solvents are dangerous when used with aluminum components in a closed fluid system.

- Consult your material supplier to determine whether your solvent or coating contains Halogenated Hydrocarbon solvents.
- Magnum Venus Products recommends that you contact your solvent supplier regarding the best non-flammable clean-up solvent with the heat toxicity for your application.
- If, however, you find it necessary to use flammable solvents, they must be kept in approved, electrically grounded containers.
- Bulk solvent should be stored in a well-ventilated, separate building, 50 feet away from your main plant.
- You should only allow enough solvent for one day's use in your laminating area.
- NO SMOKING signs must be posted and observed in all areas of storage or where solvents and other flammable materials are used.
- Adequate ventilation (as covered in OSHA Section 1910.94 and NFPA No.91) is important wherever solvents are stored or used, to minimize, confine and exhaust the solvent vapors.
- Solvents should be handled in accordance with OSHA Section 1910.106 and 1910.107.

Catalyst Diluents

Magnum Venus Products spray-up and gel-coat systems currently produced are designed so that catalyst diluents are not required. Magnum Venus Products therefore recommends that diluents not be used to avoid possible contamination which could lead to an explosion due to the handling and mixing of MEKP and diluents. In addition, it eliminates any problems from the diluent being contaminated through rust particles in drums, poor quality control on the part of the diluents suppliers, or any other reason. If diluents are absolutely required, contact your catalyst supplier and follow his instructions explicitly. Preferably the supplier should premix the catalyst to prevent possible “on the job” contamination while mixing.



WARNING

If diluents are not used, remember that catalyst spillage and gun, hose, and packing leaks are potentially more hazardous since each drop contains a higher concentration of catalyst and will therefore react more quickly with overspray and the leak.

Cured Laminate, Overspray and Laminate Sandings Accumulation

- Remove all accumulations of overspray, Fiberglass Reinforced Plastic (FRP) sandings, etc. from the building as they occur. If this waste is allowed to build up, spillage of catalyst is more likely to start a fire; in addition, the fire would burn hotter and longer.
- Floor coverings, if used, should be non-combustible.
- Spilled or leaked catalyst may cause a fire if it comes in contact with an FRP product, oversprayed chop or resin, FRP sandings or any other material with MEKP.

To prevent spillage and leakage, you should:

- | | |
|--|---|
| 1. Maintain your Magnum Venus Products System. | Check the gun several times daily for catalyst and resin packing or valve leaks. REPAIR ALL LEAKS IMMEDIATELY. |
| 2. Never leave the gun hanging over or lying inside the mold. | A catalyst leak in this situation would certainly damage the part, possibly the mold, and may cause a fire. |
| 3. Inspect resin and catalyst hoses daily for wear or stress at the entry and exits of the boom sections and at the hose and fittings. | Replace if wear or weakness is evident or suspected. |
| 4. Arrange the hoses and fiberglass roving guides so that the fiberglass strands DO NOT rub against any of the hoses at any point. | If allowed to rub, the hose will be cut through, causing a hazardous leakage of material which could increase the danger of fire. Also, the material may spew onto personnel in the area. |

Toxicity of Chemicals

- Magnum Venus Products recommends that you consult OSHA Sections 1910.94, 1910.106, 1910.107 and NFPA No.33, Chapter 14, and NFPA No.91.
- Contact your chemical supplier(s) and determine the toxicity of the various chemicals used as well as the best methods to prevent injury, irritation and danger to personnel.
- Also determine the best methods of first aid treatment for each chemical used in your plant.

Equipment Safety

Magnum Venus Products suggest that personal safety equipment such as EYE GOGGLES, GLOVES, EAR PROTECTION, and RESPIRATORS be worn when servicing or operating this equipment. Ear protection should be worn when operating a fiberglass chopper to protect against hearing loss since noise levels can be as high as 116 dB (decibels). This equipment should only be operated or serviced by technically trained personnel!



CAUTION

Never place fingers, hands, or any body part near or directly in front of the spray gun fluid tip. The force of the liquid as it exits the spray tip can cause serious injury by shooting liquid through the skin. NEVER LOOK DIRECTLY INTO THE GUN SPRAY TIP OR POINT THE GUN AT OR NEAR ANOTHER PERSON OR AN ANIMAL.



DANGER

Contaminated catalyst may cause fire or explosion. Before working on the catalyst pump or catalyst accumulator, wash hands and tools thoroughly. Be sure work area is free from dirt, grease, or resin. Clean catalyst system components with clean water daily.



DANGER

Eye, skin, and respiration hazard. The catalyst MEKP may cause blindness, skin irritation, or breathing difficulty. Keep hands away from face. Keep food and drink away from work area.

Treatment of Chemical Injuries



CAUTION

Refer to your catalyst manufacturer's safety information regarding the safe handling and storage of catalyst. Wear appropriate safety equipment as recommended.

Great care should be used in handling the chemicals (resins, catalyst and solvents) used in polyester systems. Such chemicals should be treated as if they hurt your skin and eyes and as if they are poison to your body. For this reason, Magnum Venus Products recommends the use of protective clothing and eye wear in using polyester systems. However, users should be prepared in the event of such an injury.

Precautions include:

1. Know precisely what chemicals you are using and obtain information from your chemical supplier on what to do in the event the chemical gets onto your skin or into the eyes, or if swallowed.
2. Keep this information together and easily available so that it may be used by those administering first aid or treating the injured person.
3. Be sure the information from your chemical supplier includes instructions on how to treat any toxic effects the chemicals have.

**WARNING**

Contact your doctor immediately in the event of an injury. If the product's MSDS includes first aid instructions, administer first aid immediately after contacting a doctor.

Fast treatment of the outer skin and eyes that contact chemicals generally includes immediate and thorough washing of the exposed skin and immediate and continuous flushing of the eyes with lots of clean water for at least 15 minutes or more. These general instructions of first aid treatment may be incorrect for some chemicals; you must know the chemicals and treatment before an accident occurs. Treatment for swallowing a chemical frequently depends upon the nature of the chemical.

Emergency Stop Procedure

In an emergency, follow these steps to stop a system:

1. The ball valve located where the air enters the power head of the resin pump, should be moved to the "OFF" or closed position.

Note ***The "open" or "on" position is when the ball valve handle is parallel (in line) with the ball valve body. The "closed" or "off" position is when the ball valve handle is perpendicular (across) the ball valve body.***

2. Turn all system regulators to the "OFF" position (counter-clockwise) position.
3. Verify / secure the catalyst relief line, located on the catalyst relief valve.
4. Verify / secure the resin return line, located on the resin filter.
5. Place a container under the resin pump ball valve to catch ejected resin.
6. Locate the ball valve on the resin pump.
7. Rotate the ball valve 90 degrees to the "On" or open position.

Grounding

Grounding an object means providing an adequate path for the flow of the electrical charge from the object to the ground. An adequate path is one that permits charge to flow from the object fast enough that it will not accumulate to the extent that a spark can be formed. It is not possible to define exactly what will be an adequate path under all conditions since it depends on many variables. In any event, the grounding means should have the lowest possible electrical resistance.

Grounding straps should be installed on all loose conductive objects in the spraying area. This includes material containers and equipment. Magnum Venus Products recommends grounding straps be made of AWG No.18 stranded wire as a minimum and the larger wire be used where possible. NFPA Bulletin No77 states that the electrical resistance of such a leakage path should be 1 meg ohm (10^6 ohms) or less.



CAUTION

Whenever flammable or combustible liquids are transferred from one container to another, or from one container to the equipment, both containers or container and equipment shall be effectively bonded and grounded to dissipate static electricity. For further information, see National Fire Protection Association (NFPA) 77, titled "Recommended Practice on Static Electrical". Refer especially to section 7-7 titled "Spray Application of Flammable and Combustible Materials".

Introduction

This manual provides information for the maintenance and simple repair of the MVP Patriot Metering Pump. The following procedures are included:

- Step-by-step assembly and disassembly
- Parts information



Please read this manual carefully and retain for future reference. Follow the steps in the order given, otherwise you may damage the equipment or injure yourself.

As you disassemble the equipment, lay out the components in the correct order and direction to assist with reassembly.



CAUTION

Always wear proper safety equipment including glasses and gloves when performing service on this equipment. Refer to and follow the requirements of the Material Safety Data Sheets (MSDS) supplied by your material manufacturer(s).

Required Items

You will need the following to repair the metering pump:

- 8" Adjustable wrench
- 6" Adjustable wrench
- Flathead screwdriver
- Allen wrench set

- Straight scribe
- Seal kit for the model you are servicing

**DANGER**

Contaminated catalyst may cause fire or explosion. Before working on the catalyst pump or catalyst accumulator, wash hands and tools thoroughly. Be sure work area is free from dirt, grease, or resin. Clean catalyst system components with clean water daily.

Removing Pump

1. Place a clean 5-gallon pail under the metering pump to catch any potential spills.
2. Close the main air supply ball valve to the system.
3. Open the catalyst/material manifold ball valve to the release fluid pressure.
4. Use a $\frac{5}{64}$ " Allen wrench to release catalyst accumulator charge (refer to the operations manual for your system for detailed instructions).

**WARNING**

Always release all air and fluid pressure from the system before attempting to service any components.

5. Remove the catalyst feed tube from the inlet fitting.
6. Remove the catalyst jug from its bracket and set it in a position below the metering pump.

Note ***This may require pulling out the three $\frac{1}{4}$ " poly tubing hoses from the top of the catalyst jug, depending on the unit configuration.***

7. Rock the jug back so the outlet fitting will allow the catalyst to drain back into the jug from the feed hose.
8. Use a flathead screwdriver to remove the plastic hose clamp on the metering pump inlet fitting.
9. Remove the catalyst hose fitting from the outlet body of the metering pump.
10. Push in the tube split bushing on the outlet body and pull off the $\frac{1}{4}$ " poly tubing.
11. Remove the metering pump from the drive by removing the $\frac{1}{4}$ " hex bolt on the bottom of the pump and then unscrew the knob from the top of the drive linkage.
12. Wipe the metering pump clean and inspect for wear or damage.

Disassembling Pump



DANGER

Contaminated catalyst may cause fire or explosion. Never use any type of grease or lubricants on metering pump or fittings. Clean parts in distilled water or appropriate solvent if using a hardener other than catalyst. Lay parts to be reused out on clean towels.

1. Loosen the locking nut from the inlet body and then unscrew the inlet body from the outlet body.
2. Unscrew the retaining nut from the outlet body.
3. Pull the rod end linkage and fluid rod up through the top of the outlet body.
4. Remove the rod end linkage from the fluid rod and slide the two cup seals and leak spacer from the fluid rod.
5. Remove the seal retainer and piston seal from the piston body.

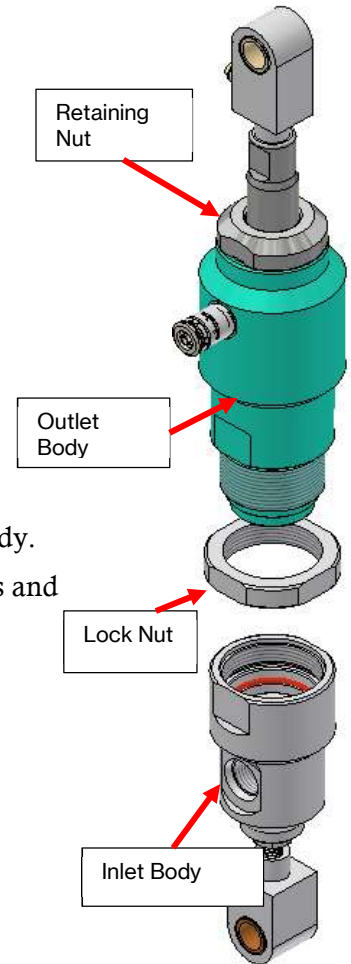
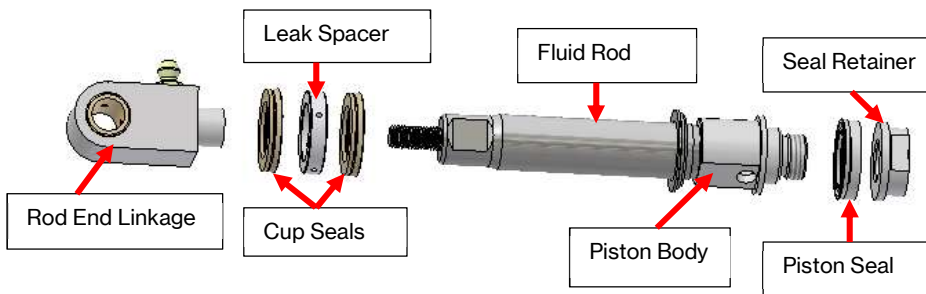

6. Remove the piston body from the fluid rod.
7. Remove the ball and spring from the piston body and fluid rod.



8. Remove the inlet and outlet fittings.
9. Remove the ball cage, ball, and O-rings from the inlet body.

Note *You will need to use a scribe to remove the ball seat O-ring.*

10. Wash all parts to be reused with distilled water or appropriate solvent (if using a hardener other than catalyst).
11. Discard all seals and O-rings from the entire pump and replace with new ones from the seal kit.
12. Inspect the fluid rod and cylinder for wear and replace as needed.



Reassembling Pump

1. Install rod seals and leak spacer into the outlet body in the following order:
 - Rod seal (O-ring facing down)
 - Leak spacer
 - Second rod seal (O-ring facing down)
2. Push the stack down into the outlet body.
3. Install the retaining nut only to hand tight.
4. Install the spring into the end of the fluid rod.
5. Put the piston ball into the piston body.
6. Use a small amount of removable thread locking compound on the thread of the fluid rod and screw the fluid rod onto the piston body.

Note *Do not overtighten; the threads are small and can become damaged easily. Allow the thread lock to dry thoroughly before putting the pump into service.*

7. Slide the piston seal onto the piston body with the piston seal facing up.
8. Use a small amount of removable thread locking compound on the threads of the piston body and screw the seal retainer onto the piston body.
9. Tighten the assembly from the fluid rod to the seal retainer.

Note *Do not overtighten; the threads are small and can become damaged easily. Allow the thread lock to dry thoroughly before putting the pump into service.*

10. Install the shaft assembly up through the bottom of the outlet body so the wrench flats on the end of the piston rod extend past the retaining nut.
11. Lightly tighten retaining nut until the nut bottoms out on the outlet body.
12. Screw the lock nut onto the outlet body until the nut bottoms out.
13. Install the ball seat O-ring into the inlet body; make sure the O-ring is completely in the groove.



14. Install the O-ring into its seat area of the inlet body.

Note *Wet the inlet body O-ring with catalyst or water to help prevent it from becoming damaged during assembly.*

15. Install the ball and ball cage into the inlet body.
16. Screw the outlet body into the inlet body until it bottoms out.

Note *If the inlet and outlet hose fittings are not in proper position to attach to the metering pump drive, back the outlet body out before bringing the lock nut*

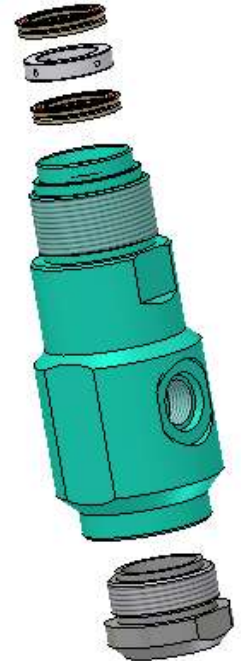

down and tightening against the inlet body. If you are not sure, complete assembly and attach to the drive before tightening the lock nut.

17. Install an O-ring onto the inlet fitting and another onto the outlet fitting.
18. Install both fittings and snug.
19. Install the rod end linkage onto the top end of the fluid rod.

Note ***Use a small amount of removable thread lock on the threads of the fluid rod. Do not overtighten; the threads are small and can become damaged easily. Allow the thread lock to dry thoroughly before putting the pump into service.***

20. Orient the outlet body so hoses do not interfere with the drive, then install the metering pump back onto the drive.
21. Bring the lock nut down onto the inlet body and tighten.
22. Attach all fluid hoses.

Parts Drawings

The following illustrations are included for reference when servicing the equipment or ordering parts. Refer to the specific drawing for the model you are working on to ensure you order the correct part numbers.

Parts Drawings	
Part Number	Description
PAT-CP-1530	Metering Pump Assembly
PAT-CP-1530-ADH	Metering Pump Assembly - Adhesive
PAT-CP-1530-S	Metering Pump Assembly - Siphon Feed
PAT-CP2-1530	Metering Pump Assembly
PAT-CP2-1530-ADH	Metering Pump Assembly - Adhesive
PAT-CP-1530-SK	Metering Pump Seal Kit
PAT-CP-1530-ADH-SK	Metering Pump Seal Kit - Adhesive
PAT-CP-3000	Metering Pump Assembly
PAT-CP-3000-ADH	Metering Pump Assembly - Adhesive
PAT-CP2-3000	Metering Pump Assembly
PAT-CP2-3000-ADH	Metering Pump Assembly - Adhesive
PAT-CP-3000-SK	Metering Pump Seal Kit
PAT-CP-3000-ADH-SK	Metering Pump Seal Kit - Adhesive

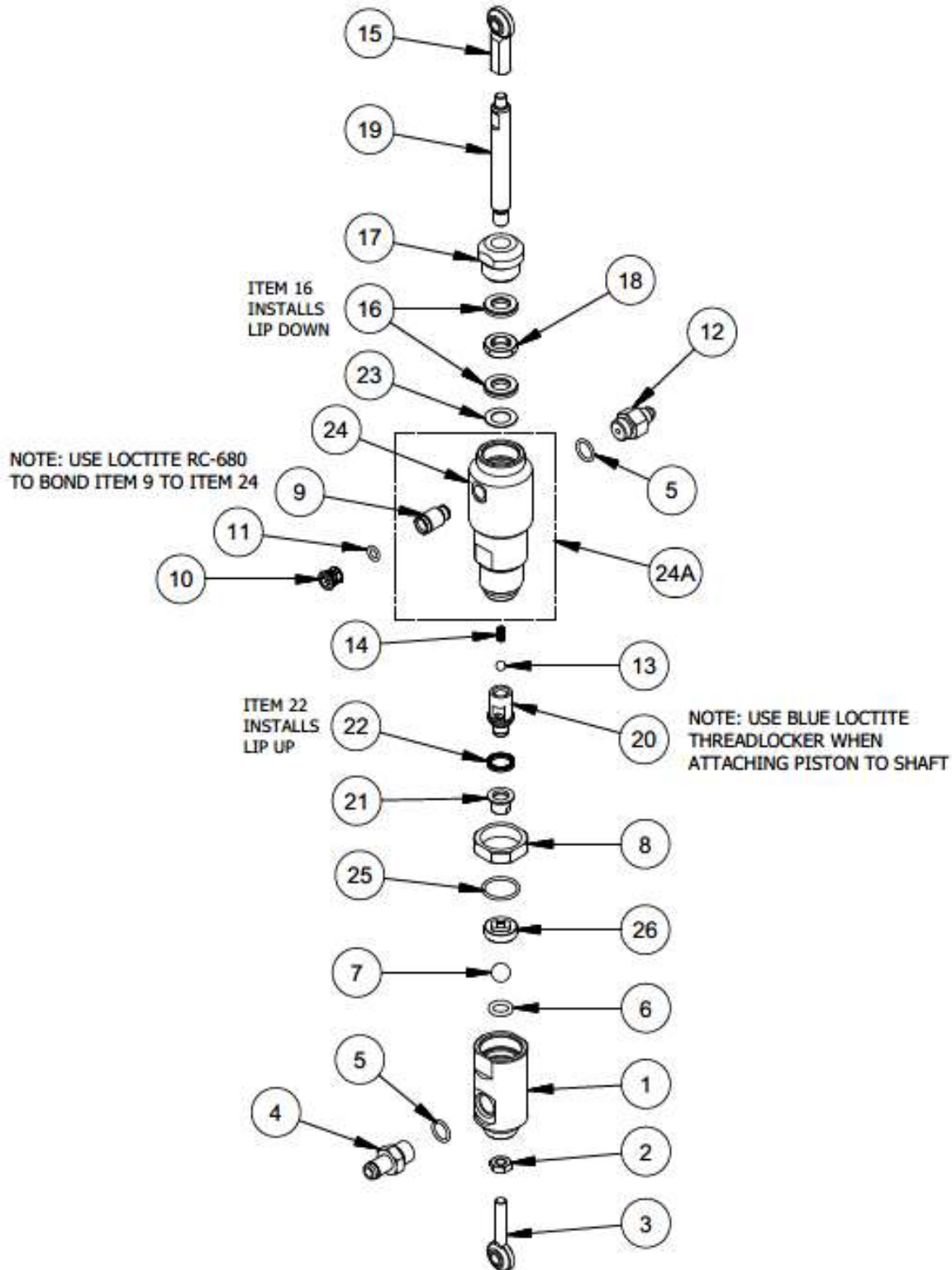

MAGNUM VENUS PRODUCTS

CATALYST PUMP	PAT-CP-1530
---------------	-------------

REV:C 03/22/2016

SHEET 1 / 2

4/27/2010

Parts List			
ITEM	PART NUMBER	QTY	DESCRIPTION
1	PAT-CP-1502	1	INLET BODY
2	F-HN-04F	1	HEX NUT
3	PAT-CP-0504	1	BALL JOINT LINKAGE
4	4101-8-1	1	INLET FITTING
* 5	O-S-013	2	O-RING
6	O-F-110	1	O-RING
7	9201-1-14	1	SS BALL Ø7/16
8	PAT-CP-1518	1	LOCKING NUT
9	PAT-CP-0505	1	FITTING BODY
10	4105-5-1	1	LOCK COLLAR
* 11	O-S-010	1	O-RING
12	51501-1	1	OUTLET FITTING
13	9201-1-7	1	SS BALL 7/32"
14	04013-1	1	PISTON SPRING
15	MS-1022	1	BALL JOINT - FEMALE
* 16	PAT-CP-1501	2	ROD SEAL
17	PAT-CP-1506	1	RETAINING NUT
* 18	PAT-CP-1507	1	LEAK SPACER
19	PAT-CP-1508	1	FLUID ROD
20	PAT-CP-1512	1	PISTON BODY
21	PAT-CP-1513	1	SEAL RETAINER
* 22	PAT-CP-1515	1	PISTON SEAL
23	PAT-CP-1516	1	BACKUP RING
24	PAT-CP-1503	1	OUTLET BODY
* 25	O-S-018	1	O-RING
26	PAT-CP-1509	1	BALL CAGE

REPAIR KIT

* PAT-CP-1530-SK (ASTERISK DENOTES PARTS IN KIT)

ASSOCIATED PARTS AND ASSEMBLIES

24A PAT-CP-1503-A OUTLET BODY ASSEMBLY

MAGNUM VENUS PRODUCTS

CATALYST PUMP

PAT-CP-1530

REV:C 03/22/2016

SHEET 2 / 2

4/27/2010

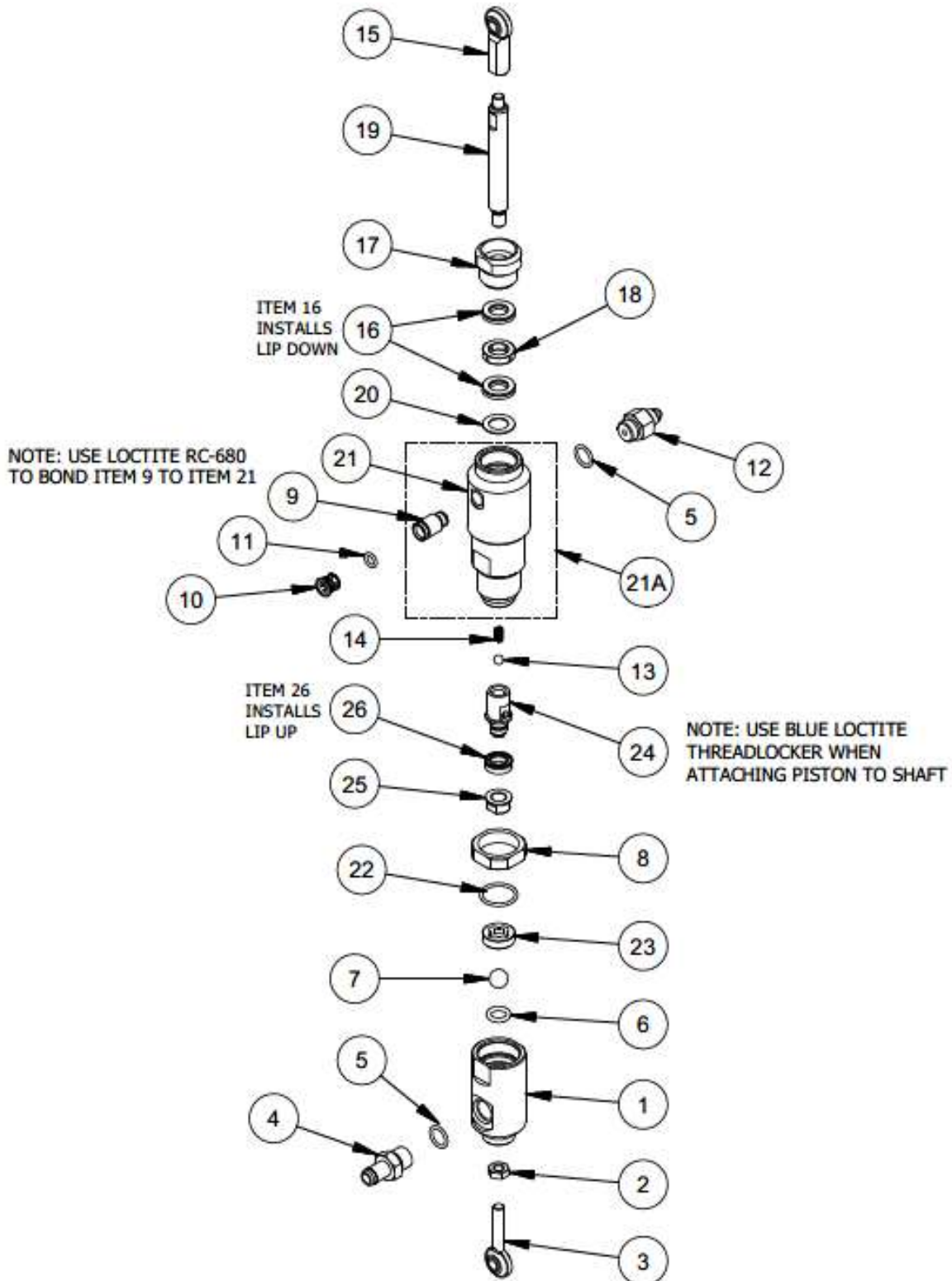

MAGNUM VENUS PRODUCTS

CATALYST PUMP

PAT-CP-1530-ADH

REV:E 03/22/2016

SHEET 1 / 2

4/27/2010

Parts List			
ITEM	PART NUMBER	QTY	DESCRIPTION
1	PAT-CP-1502	1	INLET BODY
2	F-HN-04F	1	HEX NUT
3	PAT-CP-0504	1	BALL JOINT LINKAGE
4	4101-8-1	1	INLET FITTING
* 5	O-E-013	2	O-RING
6	O-F-110	1	O-RING
7	9201-1-14	1	SS BALL Ø7/16
8	PAT-CP-1518	1	LOCKING NUT
9	PAT-CP-0505	1	FITTING BODY
10	4105-5-1	1	LOCK COLLAR
* 11	O-E-010	1	O-RING
12	51501-1	1	OUTLET FITTING
13	9201-1-7	1	SS BALL 7/32"
14	04013-1	1	PISTON SPRING
15	MS-1022	1	BALL JOINT - FEMALE
* 16	PAT-CP-1501-ADH	2	ROD SEAL ASSY
17	PAT-CP-1522	1	RETAINING NUT
* 18	PAT-CP-1507	1	LEAK SPACER
19	PAT-CP-1508	1	FLUID ROD
20	PAT-CP-1516	1	BACKUP RING
21	PAT-CP-1503	1	OUTLET BODY
* 22	O-E-018	1	O-RING
23	PAT-CP-1509	1	BALL CAGE
24	PAT-CP-1521	1	PISTON BODY
25	PAT-CP-1523	1	SEAL RETAINER
* 26	PAT-CP-1524	1	PISTON SEAL ASSY

REPAIR KIT

* PAT-CP-1530-ADH-SK (ASTERISKS NOTE PATRS IN KIT)

ASSOCIATED PARTS AND ASSEMBLIES

21A PAT-CP-1503-A OUTLET BODY ASSEMBLY

MAGNUM VENUS PRODUCTS

CATALYST PUMP

PAT-CP-1530-ADH

REV:E 03/22/2016

SHEET 2 / 2

4/27/2010

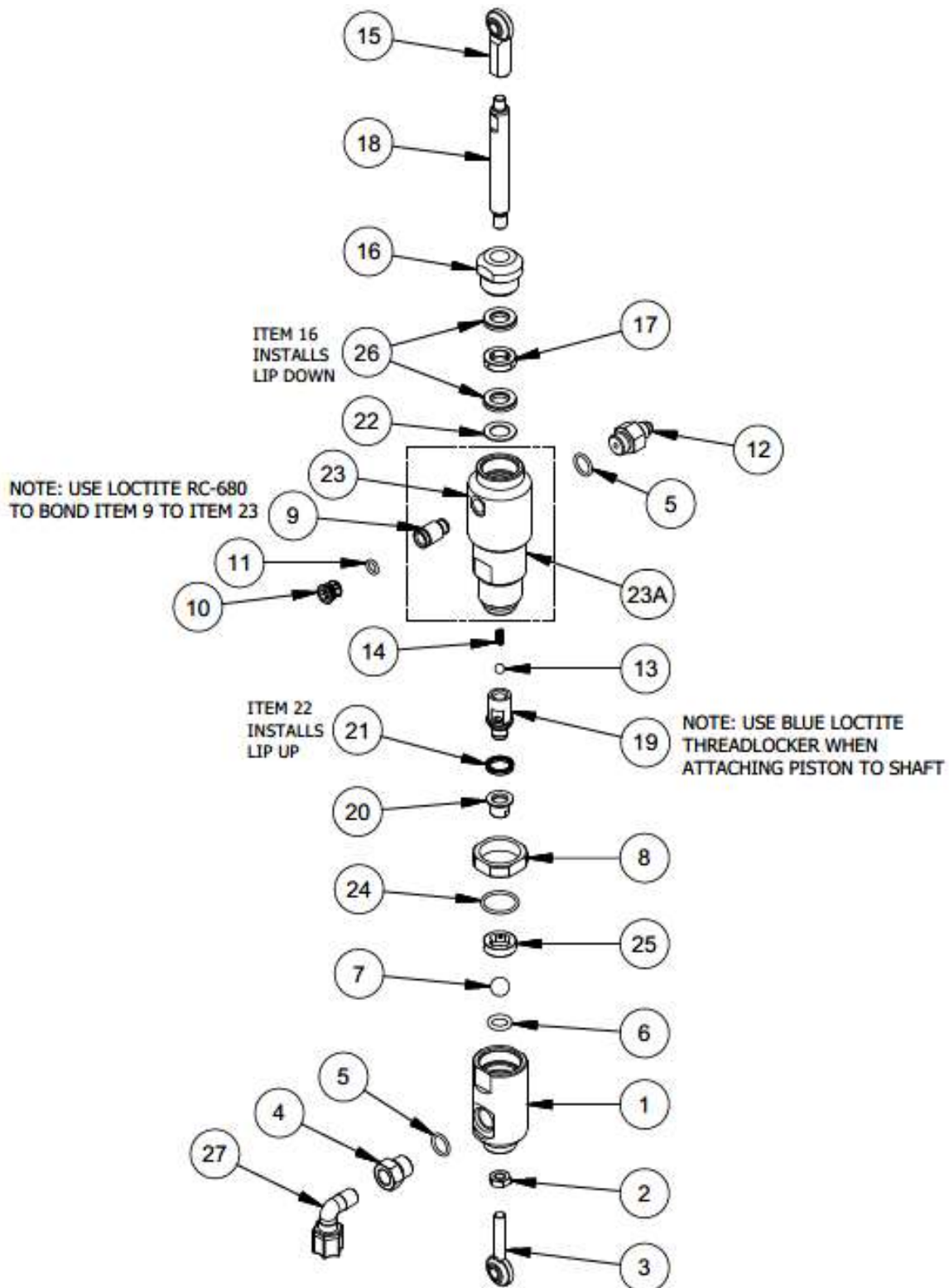

MAGNUM VENUS PRODUCTS

CATALYST PUMP	PAT-CP-1530-S
---------------	---------------

REV:C 03/22/2016

SHEET 1 / 2

12/24/2012

Parts List			
ITEM	PART NUMBER	QTY	DESCRIPTION
1	PAT-CP-1502	1	INLET BODY
2	F-HN-04F	1	HEX NUT
3	PAT-CP-0504	1	BALL JOINT LINKAGE
4	VHPC-1003	1	INLET TUBE FITTING
* 5	O-S-013	2	O-RING
6	O-F-110	1	O-RING
7	9201-1-14	1	SS BALL Ø7/16
8	PAT-CP-1518	1	LOCKING NUT
9	PAT-CP-0505	1	FITTING BODY
10	4105-5-1	1	LOCK COLLAR
* 11	O-S-010	1	O-RING
12	51501-1	1	OUTLET FITTING
13	9201-1-7	1	SS BALL 7/32"
14	04013-1	1	PISTON SPRING
15	MS-1022	1	BALL JOINT - FEMALE
16	PAT-CP-1506	1	RETAINING NUT
* 17	PAT-CP-1507	1	LEAK SPACER
18	PAT-CP-1508	1	FLUID ROD
19	PAT-CP-1512	1	PISTON BODY
20	PAT-CP-1513	1	SEAL RETAINER
* 21	PAT-CP-1515	1	PISTON SEAL
22	PAT-CP-1516	1	BACKUP RING
23	PAT-CP-1503	1	OUTLET BODY
* 24	O-S-018	1	O-RING
25	PAT-CP-1509	1	BALL CAGE
* 26	PAT-CP-1501	2	ROD SEAL
27	MS-2053	1	MALE ELBOW - TUBE

REPAIR KIT

* PAT-CP-1530-SK (ASTERISK DENOTES PARTS IN KIT)

ASSOCIATED PARTS AND ASSEMBLIES

23A PAT-CP-1503-A OUTLET BODY ASSEMBLY

MAGNUM VENUS PRODUCTS

CATALYST PUMP

PAT-CP-1530-S

REV:C 03/22/2016

SHEET 2 / 2

12/24/2012

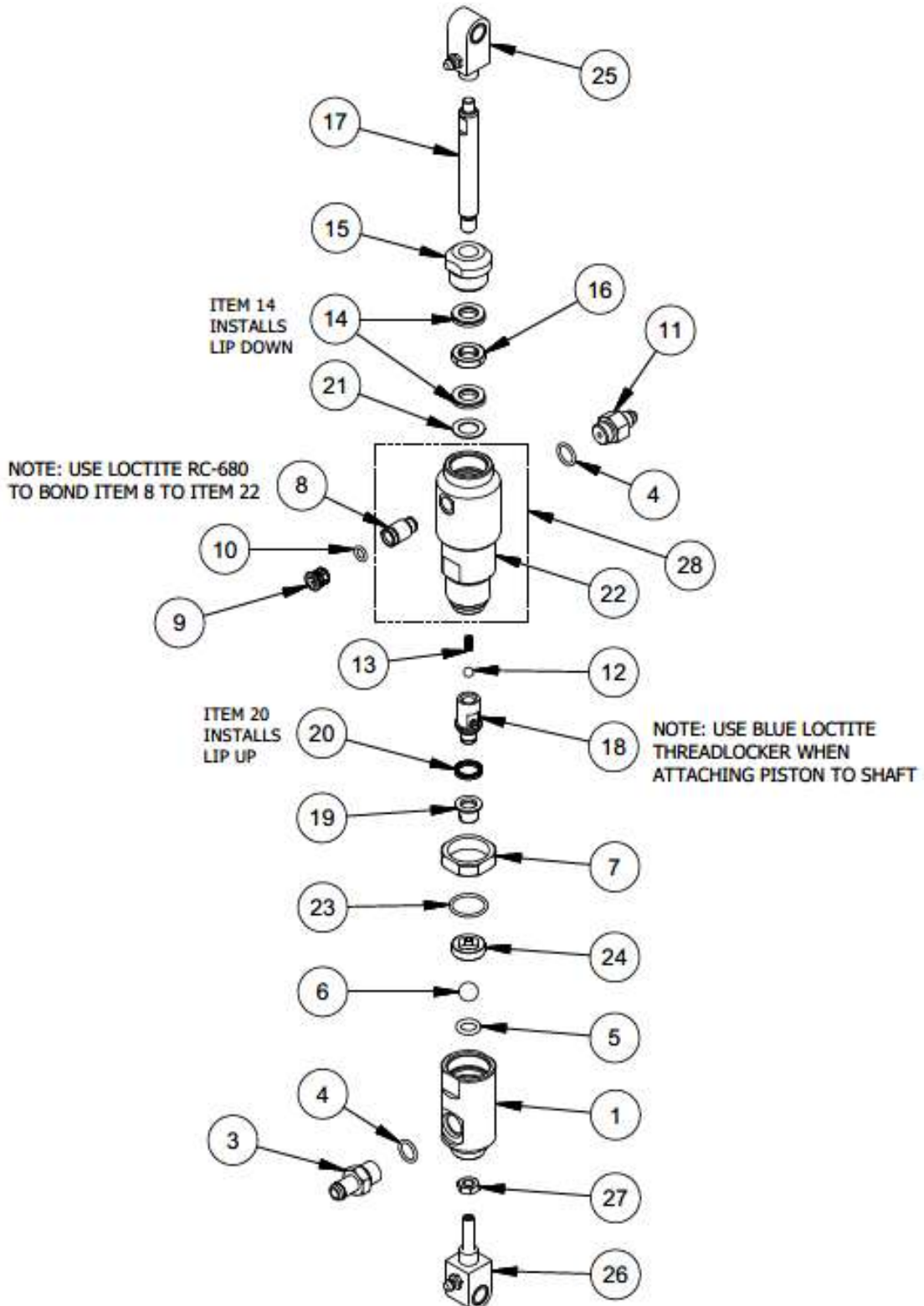

MAGNUM VENUS PLASTECH

CATALYST PUMP

PAT-CP2-1530

REV:A 03/09/2016

SHEET 1 / 2

7/23/2014

Parts List			
ITEM	PART NUMBER	QTY	DESCRIPTION
	1 PAT-CP-1502	1	INLET BODY
	3 4101-8-1	1	INLET FITTING
*	4 O-S-013	2	O-RING
	5 O-F-110	1	O-RING
	6 9201-1-14	1	SS BALL Ø7/16
	7 PAT-CP-1518	1	LOCKING NUT
	8 PAT-CP-0505	1	FITTING BODY
	9 4105-5-1	1	LOCK COLLAR
*	10 O-S-010	1	O-RING
	11 51501-1	1	OUTLET FITTING
	12 9201-1-7	1	SS BALL 7/32"
	13 04013-1	1	PISTON SPRING
*	14 PAT-CP-1501	2	ROD SEAL
	15 PAT-CP-1506	1	RETAINING NUT
*	16 PAT-CP-1507	1	LEAK SPACER
	17 PAT-CP-1508	1	FLUID ROD
	18 PAT-CP-1512	1	PISTON BODY
	19 PAT-CP-1513	1	SEAL RETAINER
*	20 PAT-CP-1515	1	PISTON SEAL
	21 PAT-CP-1516	1	BACKUP RING
	22 PAT-CP-1503	1	OUTLET BODY
*	23 O-S-018	1	O-RING
	24 PAT-CP-1509	1	BALL CAGE
	25 PAT-CP2-3041	1	ROD END ASSEMBLY
	26 PAT-CP2-3042	1	ROD END ASSEMBLY
	27 F-HN-04F	1	HEX NUT

REPAIR KIT

* PAT-CP-1530-SK (ASTERISK DENOTES PARTS IN KIT)

ASSOCIATED PARTS AND ASSEMBLIES

28 PAT-CP-1503-A OUTLET BODY ASSEMBLY

MAGNUM VENUS PLASTECH

CATALYST PUMP

PAT-CP2-1530

REV:A 03/09/2016

SHEET 2 / 2

7/23/2014

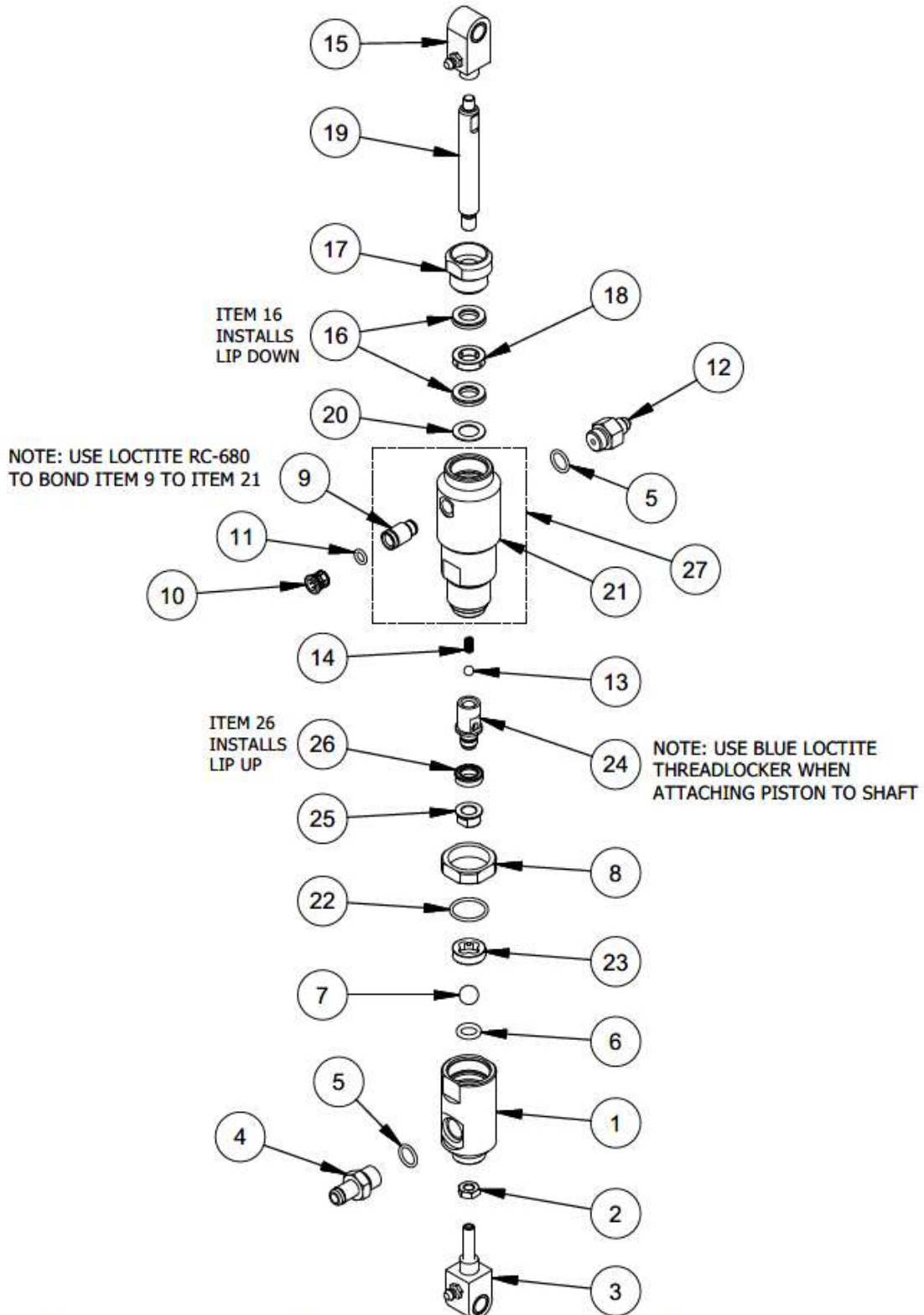

MAGNUM VENUS PRODUCTS

CATALYST PUMP

PAT-CP2-1530-ADH

REV:A 03/09/2016

SHEET 1 / 2

6/23/2015

Parts List			
ITEM	PART NUMBER	QTY	DESCRIPTION
1	PAT-CP-1502	1	INLET BODY
2	F-HN-04F	1	HEX NUT
3	PAT-CP2-3042	1	ROD END ASSEMBLY
4	4101-8-1	1	INLET FITTING
* 5	O-E-013	2	O-RING
6	O-F-110	1	O-RING
7	9201-1-14	1	SS BALL $\phi 7/16$
8	PAT-CP-1518	1	LOCKING NUT
9	PAT-CP-0505	1	FITTING BODY
10	4105-5-1	1	LOCK COLLAR
* 11	O-E-010	1	O-RING
12	51501-1	1	OUTLET FITTING
13	9201-1-7	1	SS BALL 7/32"
14	04013-1	1	PISTON SPRING
15	PAT-CP2-3041	1	ROD END ASSEMBLY
* 16	PAT-CP-1501-ADH	2	ROD SEAL ASSY
17	PAT-CP-1522	1	RETAINING NUT
* 18	PAT-CP-1507	1	LEAK SPACER
19	PAT-CP-1508	1	FLUID ROD
20	PAT-CP-1516	1	BACKUP RING
21	PAT-CP-1503	1	OUTLET BODY
* 22	O-E-018	1	O-RING
23	PAT-CP-1509	1	BALL CAGE
24	PAT-CP-1521	1	PISTON BODY
25	PAT-CP-1523	1	SEAL RETAINER
* 26	PAT-CP-1524	1	PISTON SEAL ASSY

REPAIR KIT

- * PAT-CP-1530-ADH-SK (ASTERISKS NOTE PATRS IN KIT)

ASSOCIATED PARTS AND ASSEMBLIES

- 27 PAT-CP-1503-A OUTLET BODY ASSEMBLY

MAGNUM VENUS PRODUCTS

CATALYST PUMP

PAT-CP2-1530-ADH





REV:A 03/09/2016

SHEET 2 / 2





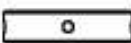

6/23/2015









PAT-CP-1530-SK
SEAL KIT

-  1 PCS
O-S-010 O-RING
-  1 PC
O-S-018 O-RING
-  2 PCS
O-S-013 O-RING
-  1 PC
PAT-CP-1515 PISTON SEAL
-  2 PCS
PAT-CP-1501 ROD SEAL
-  1 PC
PAT-CP-1507 LEAK SPACER







PAT-CP-1530-SK
SEAL KIT

-  1 PCS
O-S-010 O-RING
-  1 PC
O-S-018 O-RING
-  2 PCS
O-S-013 O-RING
-  1 PC
PAT-CP-1515 PISTON SEAL
-  2 PCS
PAT-CP-1501 ROD SEAL
-  1 PC
PAT-CP-1507 LEAK SPACER





PAT-CP-1530-SK
SEAL KIT

-  1 PCS
O-S-010 O-RING
-  1 PC
O-S-018 O-RING
-  2 PCS
O-S-013 O-RING
-  1 PC
PAT-CP-1515 PISTON SEAL
-  2 PCS
PAT-CP-1501 ROD SEAL
-  1 PC
PAT-CP-1507 LEAK SPACER



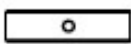

PAT-CP-1530-SK
SEAL KIT

-  1 PCS
O-S-010 O-RING
-  1 PC
O-S-018 O-RING
-  2 PCS
O-S-013 O-RING
-  1 PC
PAT-CP-1515 PISTON SEAL
-  2 PCS
PAT-CP-1501 ROD SEAL
-  1 PC
PAT-CP-1507 LEAK SPACER



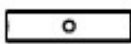

PAT-CP-1530-ADH-SK
SEAL KIT

-  1 PC
O-E-010 O-RING
-  2 PCS
O-E-013 O-RING
-  1 PC
O-E-018 O-RING
-  1 PC
PAT-CP-1524 PISTON SEAL
-  2 PCS
PAT-CP-1501-ADH ROD SEAL
-  1 PC
PAT-CP-1507 LEAK SPACER



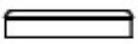
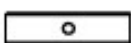

PAT-CP-1530-ADH-SK
SEAL KIT

-  1 PC
O-E-010 O-RING
-  2 PCS
O-E-013 O-RING
-  1 PC
O-E-018 O-RING
-  1 PC
PAT-CP-1524 PISTON SEAL
-  2 PCS
PAT-CP-1501-ADH ROD SEAL
-  1 PC
PAT-CP-1507 LEAK SPACER

PAT-CP-1530-ADH-SK
SEAL KIT

-  1 PC
O-E-010 O-RING
-  2 PCS
O-E-013 O-RING
-  1 PC
O-E-018 O-RING
-  1 PC
PAT-CP-1524 PISTON SEAL
-  2 PCS
PAT-CP-1501-ADH ROD SEAL
-  1 PC
PAT-CP-1507 LEAK SPACER

PAT-CP-1530-ADH-SK
SEAL KIT

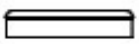
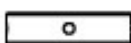
-  1 PC
O-E-010 O-RING
-  2 PCS
O-E-013 O-RING
-  1 PC
O-E-018 O-RING
-  1 PC
PAT-CP-1524 PISTON SEAL
-  2 PCS
PAT-CP-1501-ADH ROD SEAL
-  1 PC
PAT-CP-1507 LEAK SPACER

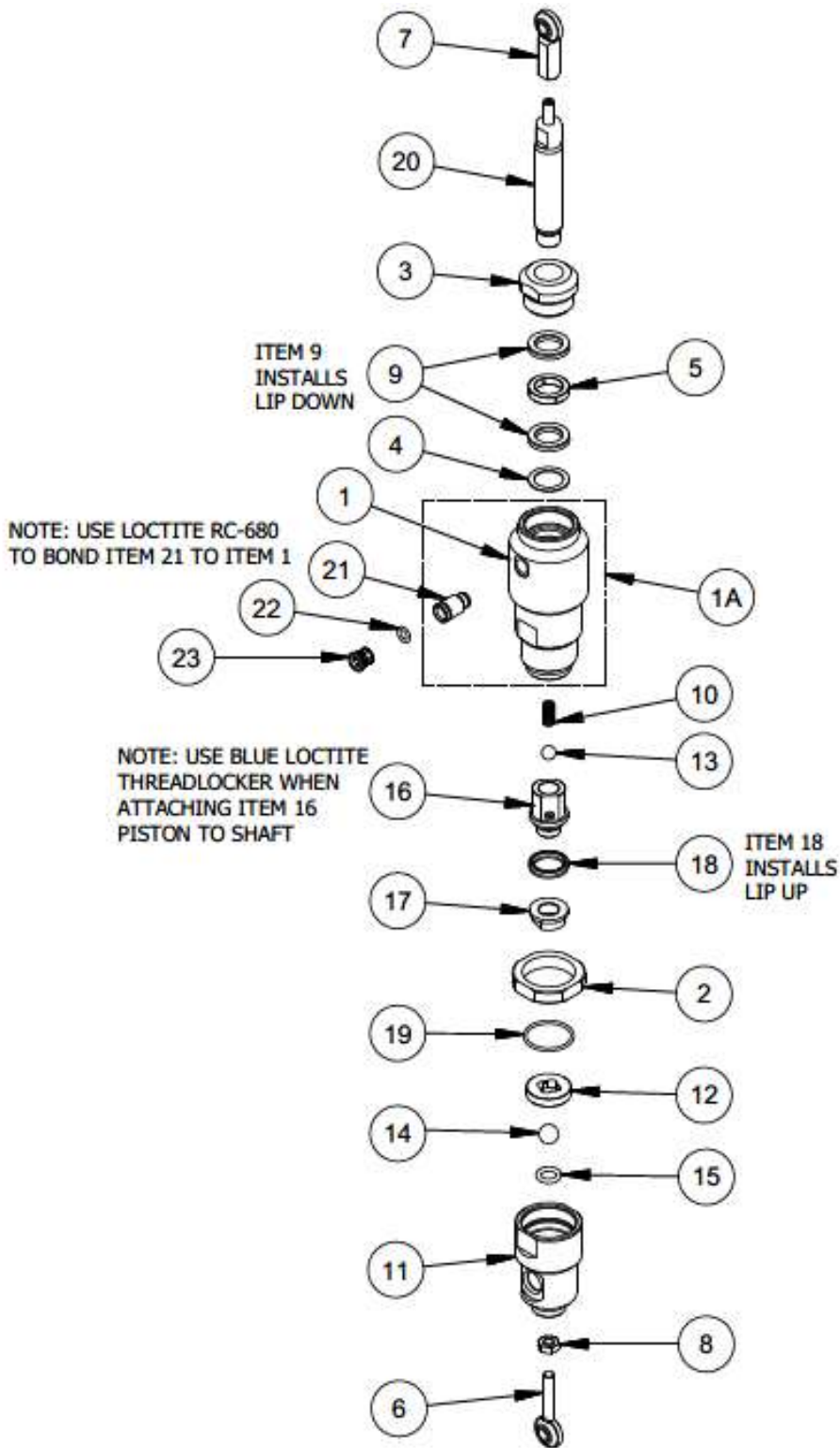

MAGNUM VENUS PRODUCTS

CATALYST PUMP ASSEMBLY	PAT-CP-3000
------------------------	-------------

REV: D 03/22/2016

SHEET 1 / 2

7/15/2013

Parts List			
ITEM	PART NUMBER	QTY	DESCRIPTION
1	PAT-CP-3003	1	OUTLET BODY
2	PAT-CP-3018	1	LOCKING NUT
3	PAT-CP-3006	1	RETAINING NUT
4	PAT-CP-3016	1	BACKUP RING
* 5	PAT-CP-3007	1	LEAK SPACER
6	PAT-CP-3042	1	BALL JOINT -MALE
7	PAT-CP-3041	1	BALL JOINT-FEMALE
8	F-HN-04F	1	HEX NUT
* 9	PAT-CP-3001	2	ROD SEAL ASSY
10	04009-1	1	PISTON SPRING - C32
11	PAT-CP-3002	1	INLET BODY
12	PAT-CP-3009	1	BALL CAGE
13	03021	1	5/16 SS BALL
14	9201-1-14	1	SS BALL \varnothing 7/16
15	O-F-110	1	O-RING
16	PAT-CP-3012	1	PISTON BODY
17	PAT-CP-3013	1	SEAL RETAINER
* 18	PAT-CP-3015	1	PISTON SEAL
* 19	O-S-022	1	O-RING
20	PAT-CP-3008	1	FLUID ROD
21	PAT-CP-0505	1	FITTING BODY
* 22	O-S-010	1	O-RING
23	4105-5-1	1	LOCK COLLAR

REPAIR KIT

* PAT-CP-3000-SK (ASTERISKS DENOTE PARTS IN KIT)

ASSOCIATED PARTS AND ASSEMBLIES

1A PAT-CP-3003-A OUTLET BODY ASSEMBLY

MAGNUM VENUS PRODUCTS

CATALYST PUMP ASSEMBLY

PAT-CP-3000

REV: D 03/22/2016

SHEET 2 / 2

7/15/2013

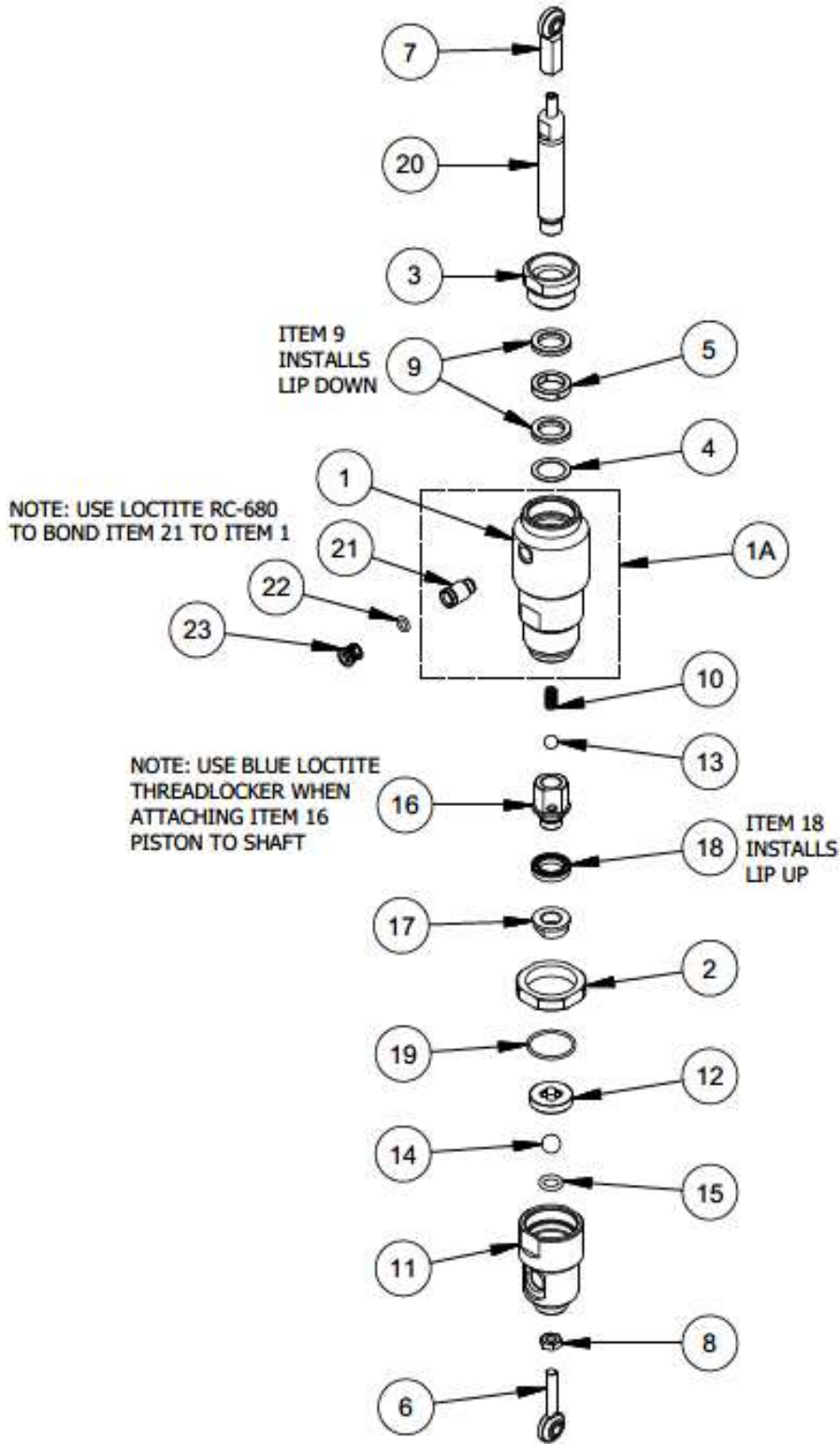

MAGNUM VENUS PRODUCTS

CATALYST PUMP ASSEMBY	PAT-CP-3000-ADH
-----------------------	-----------------

REV: C 04/04/2016

SHEET 1 / 2

7/15/2013

Parts List			
ITEM	PART NUMBER	QTY	DESCRIPTION
1	PAT-CP-3003	1	OUTLET BODY
2	PAT-CP-3018	1	LOCKING NUT
3	PAT-CP-3022	1	RETAINING NUT
4	PAT-CP-3016	1	BACKUP RING
* 5	PAT-CP-3007	1	LEAK SPACER
6	PAT-CP-3042	1	BALL JOINT -MALE
7	PAT-CP-3041	1	BALL JOINT-FEMALE
8	F-HN-04F	1	HEX NUT
* 9	PAT-CP-3001-ADH	2	ROD SEAL ASSY
10	04009-1	1	PISTON SPRING - C32
11	PAT-CP-3002	1	INLET BODY
12	PAT-CP-3009	1	BALL CAGE
13	03021	1	5/16 SS BALL
14	9201-1-14	1	SS BALL Ø7/16
15	O-F-110	1	O-RING
16	PAT-CP-3021	1	PISTON BODY
17	PAT-CP-3013	1	SEAL RETAINER
* 18	PAT-CP-3024-ADH	1	PISTON SEAL ASSY
* 19	O-E-022	1	O-RING
20	PAT-CP-3008	1	FLUID ROD
21	PAT-CP-0505	1	FITTING BODY
* 22	O-E-010	1	O-RING
23	4105-5-1	1	LOCK COLLAR

REPAIR KIT

* PAT-CP-3000-ADH-SK (ASTERISKS DENOTE PARTS IN KIT)

ASSOCIATED PARTS AND ASSEMBLIES

1A PAT-CP-3003-A OUTLET BODY ASSEMBLY

MAGNUM VENUS PRODUCTS

CATALYST PUMP ASSEMBY

PAT-CP-3000-ADH

REV: C 04/04/2016

SHEET 2 / 2

7/15/2013

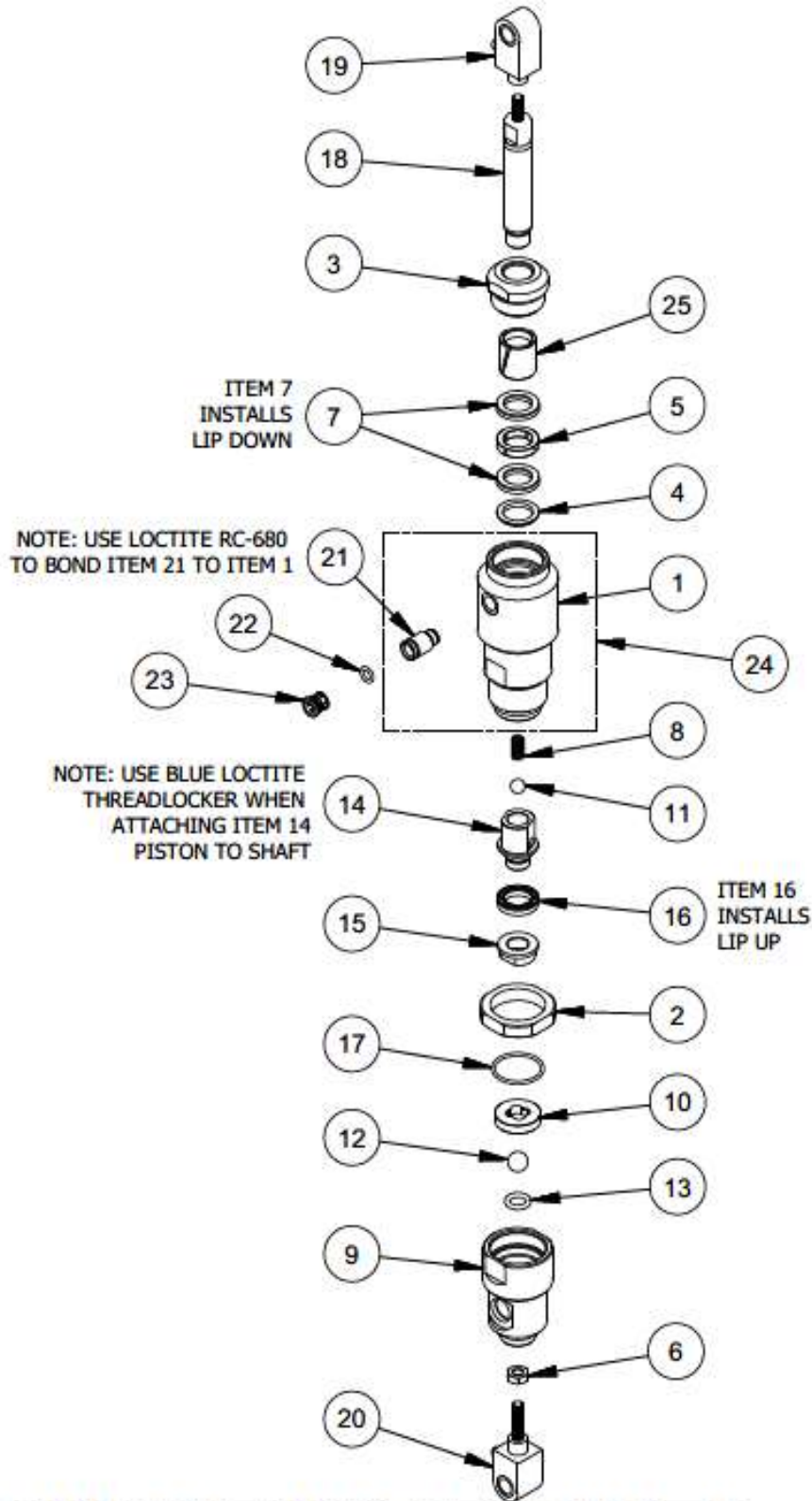

MAGNUM VENUS PRODUCTS

CATALYST PUMP ASSEMBLY	PAT-CP2-3000
------------------------	--------------

REV: C 05/08/2017

SHEET 1 / 2

7/23/2014



Parts List			
ITEM	PART NUMBER	QTY	DESCRIPTION
1	PAT-CP-3003	1	OUTLET BODY
2	PAT-CP-3018	1	LOCKING NUT
3	PAT-CP-3036	1	RETAINING NUT
4	PAT-CP-3026	1	BACKUP RING
*	PAT-CP-3007	1	LEAK SPACER
6	F-HN-04F	1	HEX NUT
*	PAT-CP-3001	2	ROD SEAL ASSY
8	04009-1	1	PISTON SPRING - C32
9	PAT-CP-3002	1	INLET BODY
10	PAT-CP-3009	1	BALL CAGE
11	03021	1	5/16 SS BALL
12	9201-1-14	1	SS BALL
13	O-F-110	1	O-RING
14	PAT-CP-3021	1	PISTON BODY
15	PAT-CP-3013	1	SEAL RETAINER
*	PAT-CP-3024	1	PISTON SEAL ASSY
*	O-S-022	1	O-RING
18	PAT-CP-3008	1	FLUID ROD
19	PAT-CP2-3041	1	ROD END ASSEMBLY
20	PAT-CP2-3042	1	ROD END ASSEMBLY
21	PAT-CP-0505	1	FITTING BODY
*	O-S-010	1	O-RING
23	4105-5-1	1	LOCK COLLAR
25	PAT-CP-3019	1	BUSHING

REPAIR KIT

* PAT-CP2-3000-SK (ASTERISKS DENOTE PARTS IN KIT)

ASSOCIATED PARTS AND ASSEMBLIES

24 PAT-CP-3003-A OUTLET BODY ASSEMBLY

MAGNUM VENUS PRODUCTS

CATALYST PUMP ASSEMBLY

PAT-CP2-3000

REV: C 05/08/2017

SHEET 2 / 2

7/23/2014

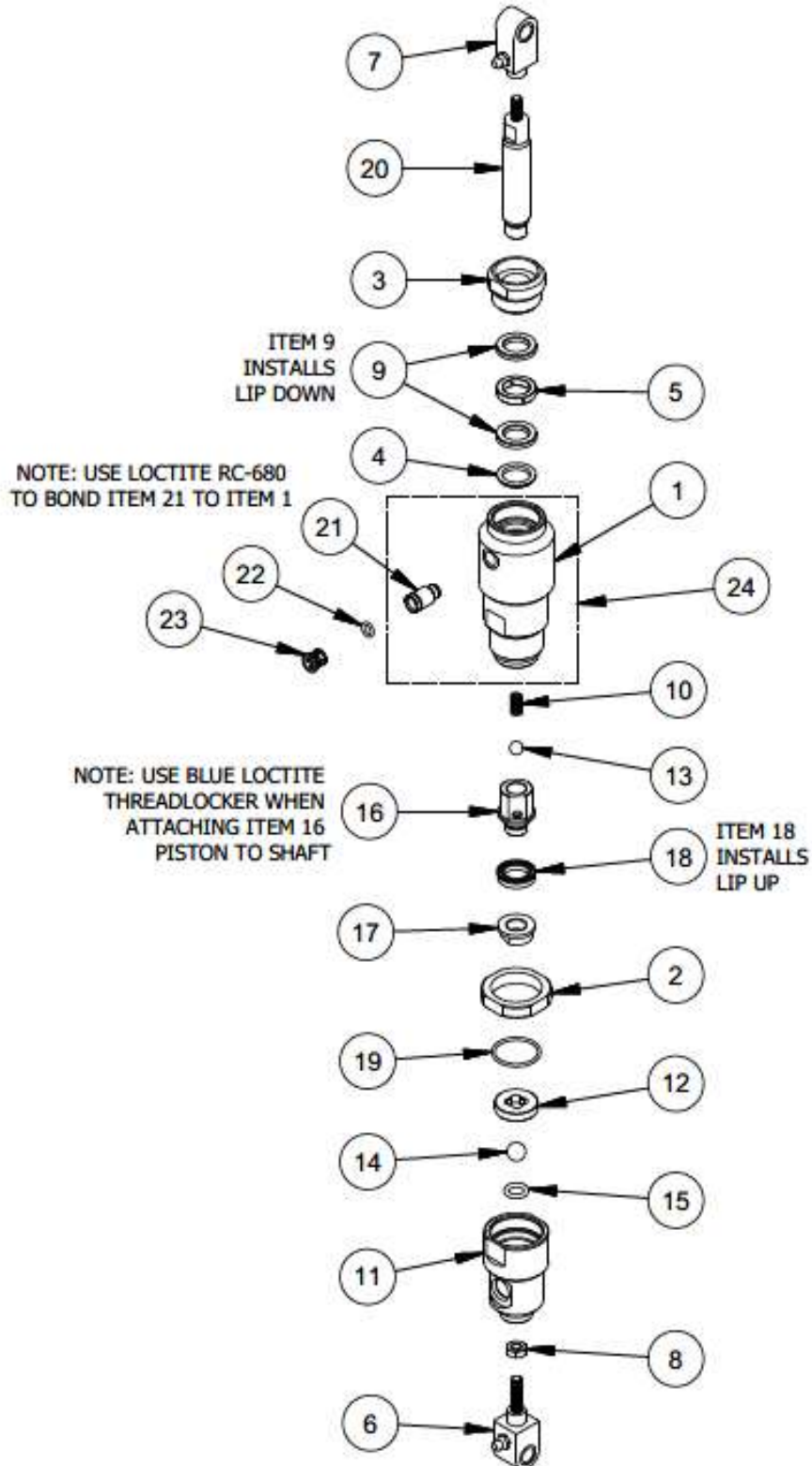

MAGNUM VENUS PRODUCTS

CATALYST PUMP	PAT-CP2-3000-ADH
---------------	------------------

REV: C 05/08/2017

SHEET 1 / 2

6/23/2015

Parts List			
ITEM	PART NUMBER	QTY	DESCRIPTION
1	PAT-CP-3003	1	OUTLET BODY
2	PAT-CP-3018	1	LOCKING NUT
3	PAT-CP-3022	1	RETAINING NUT
4	PAT-CP-3026	1	BACKUP RING
* 5	PAT-CP-3007	1	LEAK SPACER
6	PAT-CP2-3042	1	ROD END ASSEMBLY
7	PAT-CP2-3041	1	ROD END ASSEMBLY
8	F-HN-04F	1	HEX NUT
* 9	PAT-CP-3001-ADH	2	ROD SEAL ASSY
10	04009-1	1	PISTON SPRING - C32
11	PAT-CP-3002	1	INLET BODY
12	PAT-CP-3009	1	BALL CAGE
13	03021	1	5/16 SS BALL
14	9201-1-14	1	SS BALL
15	O-F-110	1	O-RING
16	PAT-CP-3021	1	PISTON BODY
17	PAT-CP-3013	1	SEAL RETAINER
* 18	PAT-CP-3024-ADH	1	PISTON SEAL ASSY
* 19	O-E-022	1	O-RING
20	PAT-CP-3008	1	FLUID ROD
21	PAT-CP-0505	1	FITTING BODY
* 22	O-E-010	1	O-RING
23	4105-5-1	1	LOCK COLLAR

REPAIR KIT

* PAT-CP-3000-ADH-SK (ASTERISKS DENOTE PARTS IN KIT)

ASSOCIATED PARTS AND ASSEMBLIES

24 PAT-CP-3003-A OUTLET BODY ASSEMBLY

MAGNUM VENUS PRODUCTS

CATALYST PUMP

PAT-CP2-3000-ADH

REV: C 05/08/2017

SHEET 2 / 2

6/23/2015

PAT-CP-3000-SK
SEAL KIT



1 PC
O-S-022 O-RING



1 PC
PAT-CP-3015 PISTON SEAL



2 PCS
PAT-CP-3001 ROD SEAL

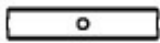

1 PC
PAT-CP-3007 LEAK SPACER

PAT-CP-3000-SK
SEAL KIT



1 PC
O-S-022 O-RING



1 PC
PAT-CP-3015 PISTON SEAL



2 PCS
PAT-CP-3001 ROD SEAL

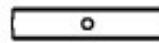

1 PC
PAT-CP-3007 LEAK SPACER

PAT-CP-3000-SK
SEAL KIT



1 PC
O-S-022 O-RING



1 PC
PAT-CP-3015 PISTON SEAL



2 PCS
PAT-CP-3001 ROD SEAL

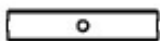

1 PC
PAT-CP-3007 LEAK SPACER

PAT-CP-3000-SK
SEAL KIT



1 PC
O-S-022 O-RING



1 PC
PAT-CP-3015 PISTON SEAL



2 PCS
PAT-CP-3001 ROD SEAL

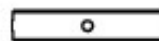

1 PC
PAT-CP-3007 LEAK SPACER

PAT-CP-3000-ADH-SK
SEAL KIT



1 PC
O-E-022 O-RING



1 PC
PAT-CP-3024-ADH PISTON SEAL



2 PCS
PAT-CP-3001-ADH ROD SEAL

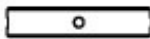

1 PC
PAT-CP-3007 LEAK SPACER

PAT-CP-3000-ADH-SK
SEAL KIT



1 PC
O-E-022 O-RING



1 PC
PAT-CP-3024-ADH PISTON SEAL



2 PCS
PAT-CP-3001-ADH ROD SEAL

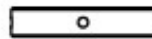

1 PC
PAT-CP-3007 LEAK SPACER

PAT-CP-3000-ADH-SK
SEAL KIT



1 PC
O-E-022 O-RING



1 PC
PAT-CP-3024-ADH PISTON SEAL



2 PCS
PAT-CP-3001-ADH ROD SEAL

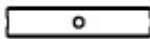

1 PC
PAT-CP-3007 LEAK SPACER

PAT-CP-3000-ADH-SK
SEAL KIT



1 PC
O-E-022 O-RING



1 PC
PAT-CP-3024-ADH PISTON SEAL



2 PCS
PAT-CP-3001-ADH ROD SEAL

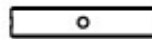

1 PC
PAT-CP-3007 LEAK SPACER



Magnum Industries Europe Ltd. t/a Magnum Venus Products

Official Distributor of MVP Range in the United Kingdom and Ireland

Unit 22a, Navigation Drive, Hurst Business Park,
Brierley Hill, West Midlands, DY5 1UT, UK.

phone: +44 (0)1384 486222
email: info@mvpeurope.co.uk
website: www.mvpeurope.co.uk